

# Electricity Energy Storage Technology Options

A White Paper Primer on Applications, Costs and Benefits





# **Electricity Energy Storage Technology Options**

A White Paper Primer on Applications, Costs and  
Benefits

**1020676**

Final Report, December 2010

EPRI Project Manager  
D. Rastler

## **DISCLAIMER OF WARRANTIES AND LIMITATION OF LIABILITIES**

THIS DOCUMENT WAS PREPARED BY THE ORGANIZATION(S) NAMED BELOW AS AN ACCOUNT OF WORK SPONSORED OR COSPONSORED BY THE ELECTRIC POWER RESEARCH INSTITUTE, INC. (EPRI). NEITHER EPRI, ANY MEMBER OF EPRI, ANY COSPONSOR, THE ORGANIZATION(S) BELOW, NOR ANY PERSON ACTING ON BEHALF OF ANY OF THEM:

(A) MAKES ANY WARRANTY OR REPRESENTATION WHATSOEVER, EXPRESS OR IMPLIED, (I) WITH RESPECT TO THE USE OF ANY INFORMATION, APPARATUS, METHOD, PROCESS, OR SIMILAR ITEM DISCLOSED IN THIS DOCUMENT, INCLUDING MERCHANTABILITY AND FITNESS FOR A PARTICULAR PURPOSE, OR (II) THAT SUCH USE DOES NOT INFRINGE ON OR INTERFERE WITH PRIVATELY OWNED RIGHTS, INCLUDING ANY PARTY'S INTELLECTUAL PROPERTY, OR (III) THAT THIS DOCUMENT IS SUITABLE TO ANY PARTICULAR USER'S CIRCUMSTANCE; OR

(B) ASSUMES RESPONSIBILITY FOR ANY DAMAGES OR OTHER LIABILITY WHATSOEVER (INCLUDING ANY CONSEQUENTIAL DAMAGES, EVEN IF EPRI OR ANY EPRI REPRESENTATIVE HAS BEEN ADVISED OF THE POSSIBILITY OF SUCH DAMAGES) RESULTING FROM YOUR SELECTION OR USE OF THIS DOCUMENT OR ANY INFORMATION, APPARATUS, METHOD, PROCESS, OR SIMILAR ITEM DISCLOSED IN THIS DOCUMENT.

ORGANIZATION(S) THAT PREPARED THIS REPORT:

**Electric Power Research Institute**

**Energy and Environmental Economics, Inc.**

## **NOTE**

For further information about EPRI, call the EPRI Customer Assistance Center at 800.313.3774 or e-mail [askepri@epri.com](mailto:askepri@epri.com).

Electric Power Research Institute, EPRI, and TOGETHER...SHAPING THE FUTURE OF ELECTRICITY are registered service marks of the Electric Power Research Institute, Inc.

Copyright © 2010 Electric Power Research Institute, Inc. All rights reserved.

# ACKNOWLEDGEMENTS

---

This white paper was prepared by

Electric Power Research Institute  
3420 Hillview Avenue  
Palo Alto, California 94304

Principal Investigator  
D. Rastler

EPRI wishes to thank the energy storage vendors, system integrators and industry stakeholders who provided valuable input and comments and input to this document.

EPRI would like to thank and acknowledge Eric Cutter, David Miller and Lakshmi Alagappan at Energy and Environmental Economics, Inc., who provided detailed analytics and supporting analysis.

EPRI also likes to thank and acknowledge David Gauntlett at AECOM who worked very closely with participating vendors, suppliers and system integrators in compiling the extensive background data which is summarized in this report.

The author would also like to thank his close colleagues at EPRI for their support and valuable comments: Ben Kaun, Haresh Kamath, Bill Steeley, Robert Schainker and Sean Wright.

This report describes research sponsored by the Electric Power Research Institute (EPRI).

This publication is a corporate document that should be cited in the literature in the following manner:

*Electric Energy Storage Technology Options: A White Paper Primer on Applications, Costs and Benefits.* EPRI, Palo Alto, CA, 2010. 1020676.



# ABSTRACT

---

A confluence of industry drivers—including increased deployment of renewable generation, the high capital cost of managing grid peak demands, and large capital investments in grid infrastructure for reliability—is creating new interest in electric energy storage systems. New EPRI research offers a current snapshot of the storage landscape and an analytical framework for estimating the benefits of applications and life-cycle costs of energy storage systems.

This paper describes in detail 10 key applications which can support the entire chain of the electrical system, from generation and system-level applications through T&D system applications to end-user applications. Included are: wholesale energy services, renewables integration, large and small storage and transportable systems for T&D grid support, ESCO aggregated systems, commercial and industrial power quality and reliability, commercial and industrial energy management, home energy management, and home back-up storage. Capturing multiple benefits—including transmission and distribution (T&D) deferral, local or system capacity, and frequency regulation—was found to be key for high-value applications and for supporting the business case for energy storage. Applications that achieve the highest revenues do so by aggregating several benefits across multiple categories. An analytic framework is presented to estimate the benefits and life-cycle costs, and help guide and shape the economic treatment of energy storage systems. Because energy storage systems have multi-functional characteristics, which complicates rules for ownership and operation among various stakeholders, policy challenges were identified that need to be resolved to realize the true potential of storage assets.

The current status of energy storage technology options and updated estimated ranges for their total installed costs, performance, and capabilities for key applications is also presented based on technology assessments as well as discussions with vendors and system integrators. Despite the large need for energy storage solutions, very few grid-integrated storage installations are in actual operation in the United States. This landscape is expected to change around 2012, when a host of new storage options supported by U.S. stimulus funding begins to emerge and, in turn, catalyzes a portfolio of new energy storage demonstrations. Such tests in real-world trials will provide needed data and information on the robustness of such systems, including performance and durability, cycle life costs, and risks.

As a key industry stakeholder, electric utilities are positioned to support energy storage applications because they can test, evaluate and deploy applications in different sections of the electricity value and supply chain, and enable the monetization of benefits of the various stakeholders. The high-value markets identified can help focus future demonstration activities to advance the deployment and adoption of energy storage systems.





# CONTENTS

---

- EXECUTIVE SUMMARY ..... 1**
  - Introduction ..... 1
  - The Current Landscape..... 2
  - Applications for Electric Energy Storage ..... 5
  - Energy Storage Application Requirements and Value of Benefits ..... 8
  - Analytical Methodology and Key Conclusions..... 11
  - Market Size and Scale for Energy Storage in the United States..... 13
  - Energy Storage System Costs ..... 17
  - Gap Analysis ..... 20
  - Levelized Costs of Delivered Energy and Capacity ..... 21
  - Conclusions..... 23
    - Policy Implications ..... 24
    - Role for Electric Utilities..... 25
    - Recommendations..... 26
  
- 1 INTRODUCTION ..... 1-1**
  - Purpose ..... 1-1
  - Background ..... 1-2
  - Expectations..... 1-5
  - Uncertainties and Accuracy..... 1-7
    - Sources of Uncertainty ..... 1-7
    - Accuracy ..... 1-8
  
- 2 ENERGY STORAGE APPLICATION REQUIREMENTS AND BENEFITS ..... 2-1**
  - Electric Energy Storage Applications ..... 2-1
  - Energy Storage Application Requirements and Value of Benefits ..... 2-5
  - Energy Storage Application Values..... 2-7
  - Comparison to Alternative Energy Storage Benefit Valuations ..... 2-12

<b>3 MARKET SIZE &amp; POTENTIAL</b> .....	<b>3-1</b>
Approach to Market Analysis.....	3-1
Analysis of Markets for Energy Storage Applications.....	3-4
System Applications .....	3-4
Wind Integration .....	3-5
Photovoltaic Integration .....	3-8
Utility Applications .....	3-9
Distributed Energy Storage Applications .....	3-10
Commercial & Industrial Applications .....	3-12
Residential Applications .....	3-13
Market Size Summary .....	3-14
Comparison to Alternative Energy Storage Market Size Approaches.....	3-16
Market Rules and Impact on Energy Storage Value .....	3-17
<b>4 TECHNOLOGY OPTIONS: ENERGY STORAGE SOLUTIONS AND SYSTEM COSTS</b> .....	<b>4-1</b>
Energy Storage Solutions and Options .....	4-1
Pumped Hydro.....	4-2
Compressed Air Energy Storage (CAES).....	4-4
Lead-Acid Batteries .....	4-6
Advanced Lead-Acid Batteries .....	4-8
Sodium-Sulfur (NaS) .....	4-9
Sodium Nickel Chloride .....	4-11
Vanadium Redox.....	4-11
Zinc-Bromine (Zn/Br) .....	4-12
Fe/Cr and Zn/Air .....	4-14
Flywheels.....	4-15
Lithium-Ion (Li-ion).....	4-17
Representative Cost and Performance .....	4-21
Emerging Energy Storage Technologies.....	4-31
<b>5 DISCUSSION AND CONCLUSIONS</b> .....	<b>5-1</b>
Gap Analysis .....	5-1
Levelized Costs of Delivered Energy and Capacity .....	5-3
Conclusions.....	5-6
Policy Implications .....	5-7

Role for Electric Utilities.....	5-8
<b>6 RECOMMENDATIONS FOR FUTURE WORK.....</b>	<b>6-1</b>
Recommendations .....	6-1
<b>A APPENDIX: FRAMEWORK AND METHODOLOGY FOR VALUATION OF ENERGY STORAGE APPLICATIONS .....</b>	<b>A-1</b>
Introduction .....	A-1
End User Benefits .....	A-3
Improved Power Quality .....	A-3
Improved Power Reliability .....	A-5
Reduce Retail TOU Energy Charges .....	A-7
Reduce Retail Demand Charges.....	A-9
Distribution System Benefits .....	A-12
Provide Voltage Support.....	A-12
Defer Distribution Investment .....	A-12
Reduce Distribution Losses.....	A-13
Transmission System Benefits.....	A-13
VAR Support.....	A-13
Reduce Transmission Congestion.....	A-14
Reduce Transmission Access Charges.....	A-16
Defer Transmission Investment.....	A-16
System Benefits .....	A-17
Provide Local Capacity.....	A-17
System Capacity/Resource Adequacy .....	A-18
Renewable Energy Integration .....	A-18
ISO Market Benefits .....	A-19
Regulation .....	A-19
Fast Regulation .....	A-20
Spinning Reserves .....	A-20
Non-Spinning/Replacement Reserves .....	A-21
Black Start .....	A-21
Energy Arbitrage.....	A-22
Non-quantifiable Benefits .....	A-22
Renewable Energy Integration Components.....	A-23
Renewable Energy Seasonal Output Shifting .....	A-23

Reduce Imbalance Energy Charges.....	A-23
Reducing Size of Transmission Line .....	A-23
Energy Storage Benefits .....	A-24
Fossil Plant Operational Cost Savings .....	A-24
Energy Storage Applications .....	A-26
Modeling Approach.....	A-27
Present Value .....	A-28
Gap Analysis .....	A-28
Levelized Cost Assumptions .....	A-34

# EXECUTIVE SUMMARY

---

## Introduction

A confluence of industry drivers—including increased deployment of renewable generation, the high capital cost of managing grid peak demands, and large investments in grid infrastructure for reliability and smart grid initiatives—is creating new interest in electric energy storage systems. Just as transmission and distribution (T&D) systems move electricity over distances to end users, energy storage systems can move electricity through *time*, providing it when and where it is needed. Energy storage systems can help balance variable renewable generation and, properly deployed and integrated, can help increase electric grid reliability and asset utilization. With improvements in the cost and commercial availability of energy storage technologies, electricity storage systems should play a pivotal role in influencing the impact of these industry drivers.

This white paper was prepared to inform industry executives, policymakers, and other industry stakeholders of the various types of electric energy storage systems both available and emerging: their status, potential applications, and important trends in such systems for the electric enterprise. Cost and application value information is crucial to assessing the business case for energy storage system investments. However, traditional methods used to evaluate distributed energy resources (DER) do not adequately capture the range of benefits potentially offered by energy storage systems.

Storage applications differ from other DER options, such as distributed generation or energy efficiency, in key respects: they do not have a typical operating profile or load shape that can be applied prospectively; they are “limited energy” resources with a narrow band of dispatch and operation; and they can participate in multiple wholesale markets and provide several benefits simultaneously to the wholesale system, electric distribution companies, and end-use customers. These characteristics, plus the difficulty in monetizing multiple stakeholder benefits, often act as barriers to the widespread deployment of energy storage systems, whose multi-functional characteristics also complicate rules for ownership and operation among various stakeholders.

In producing this report, EPRI’s Energy Storage research program drew on information from technology assessments, market research and analysis, application assessments, and input from storage system vendors and system integrators on performance and capital costs. The paper provides an overview of energy storage applications and technology options, and the potential range of value of storage systems in the applications presented. Updated capital cost and performance information is also presented for storage systems available within the next one to three years. In addition, longer-term trends in emerging systems are highlighted. The full report also outlines a framework and methodology that

electric utilities and industry stakeholders may use as one approach to estimating the value of energy storage systems in key near-term applications.

The conclusions of this work are the result of modeling efforts and calculations conducted at EPRI. Assumptions and estimates for many of these calculations have been developed by industry experts and vetted by stakeholders, but real-world needs, costs, and benefits can vary considerably. The objective of this study is to provide information and data that are timely and relevant, but with the consideration that readers carefully understand the assumptions and calculations made to reach the conclusions presented. A number of the high-value benefits identified in this report can vary widely across regions and will depend to a great extent on the operational guidelines, market rules and tariffs ultimately adopted for energy storage. Furthermore, as a broad survey of markets and technologies, this report does not take into account the substantial impact of local and site-specific conditions when looking at applications for energy storage, cost estimates must be considered “simplified” or “preliminary.” Many of the energy storage system cost, performance, and cycle-life data presented need to be supported and validated by real-world field trials. With some exceptions, very few of the systems discussed in this report have been fully tested and verified at the scale of the stated applications. Therefore, uncertainties in cost, performance, and cycle life as well as technology operational risk should be considered when planning for the use of these resources.

Because a consistent methodology was applied to develop the estimates, EPRI believes these conclusions will be useful for utility planners, policymakers, and other interested stakeholders. This document should help readers gain a deep understanding of the energy storage technology landscape, identify potential applications in the electric energy storage sector, and compare various alternative energy storage technologies by application.

## **The Current Landscape**

There are a variety of potential energy storage options for the electric sector, each with unique operational, performance, and cycling and durability characteristics. Figure ES-1 provides comparative estimates of total current installed capacity worldwide.

While many forms of energy storage have been installed, pumped hydro systems are by far the most widely used, with more than 127,000 megawatts (MW) installed worldwide. Compressed air energy storage (CAES) installations (Figure ES-2) are the next largest, followed by sodium-sulfur batteries. All remaining energy storage resources worldwide total less than 85 MW combined, and consist mostly of a few one-off installations.

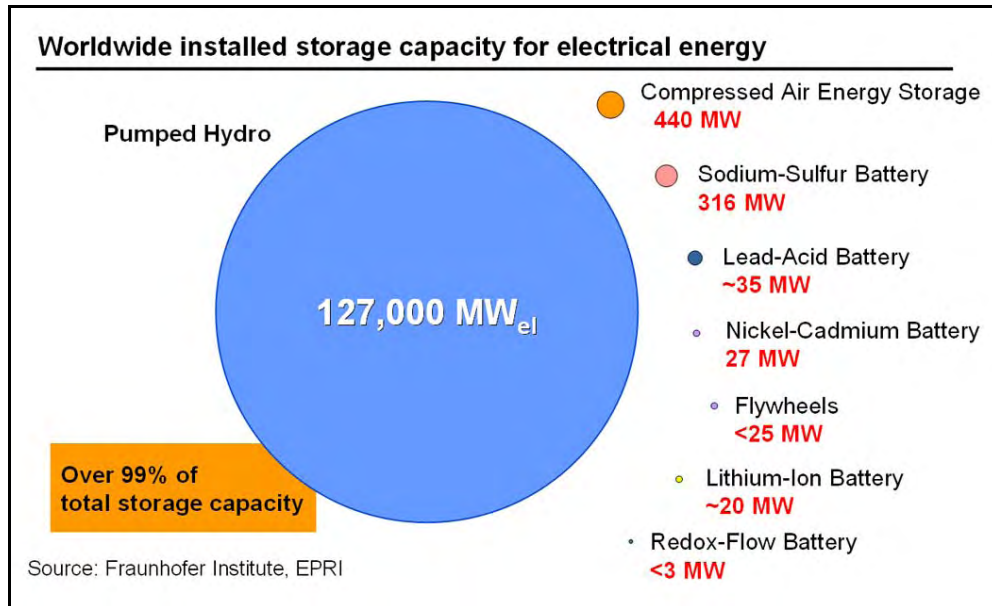

**Figure ES-1**  
**Worldwide Installed Storage Capacity for Electrical Energy**



**Figure ES-2**  
**Underground CAES Plant, Alabama**

Despite the large anticipated need for energy storage solutions within the electric enterprise, very few grid-integrated storage installations are in actual operation in the United States today. This landscape is expected to change around 2011–2012, when a host of new storage options supported by more than \$250 million in U.S. stimulus funding begin to emerge and, in turn, catalyze a portfolio of new energy storage demonstrations. Such tests in real-world trials will provide needed data and information on the robustness of such systems, including performance and durability, cycle life costs, and risks. These data will be essential in advancing the learning for grid integration and application values detailed in this report. Figure ES-3 illustrates a few of the key demonstrations planned

which, if successful, will contribute to the technical readiness and further adoption of storage solutions by 2015.

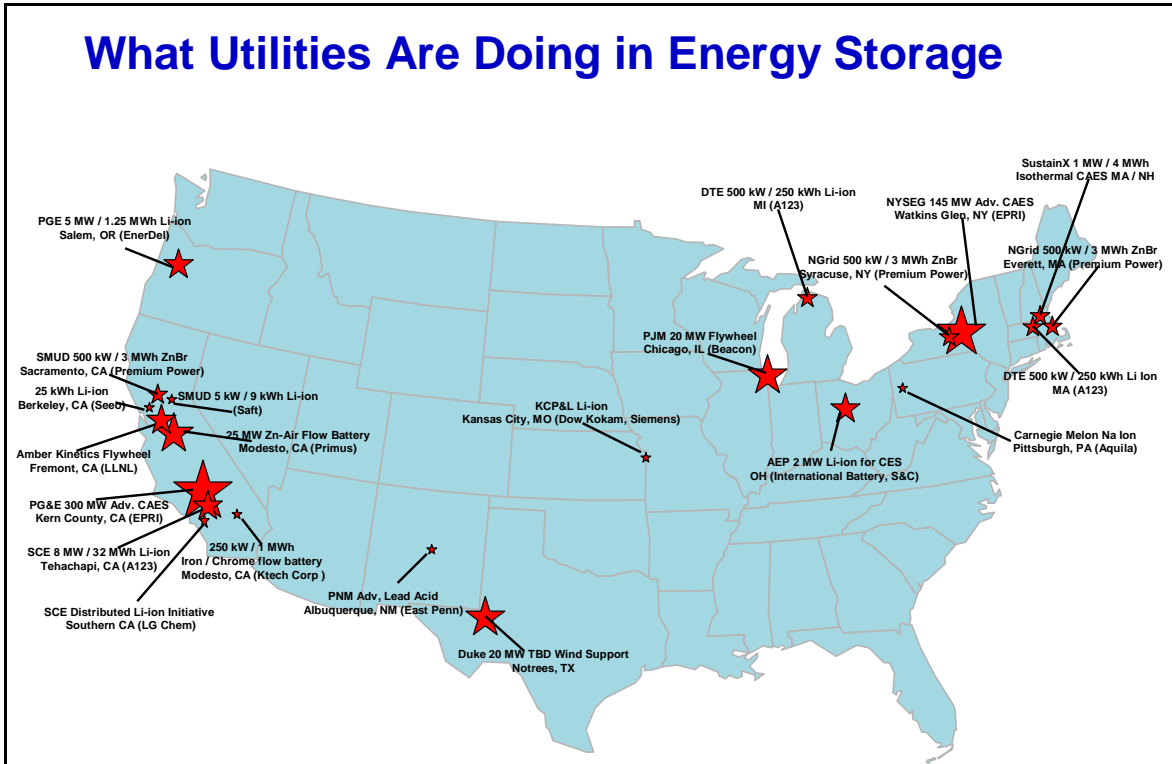

Figure ES-3  
ARRA-Funded Utility Energy Storage Projects



Figure ES-4  
Premium Power's 0.5-MW/2.8 MWh TransFlow 2000 Transportable Zinc-Bromine Energy Storage System Preparing for Demonstration by EPRI.

Each type of energy storage technology has its own capital cost and operating cost parameters, which are described in the full paper. In general, based on present-day technology, some energy storage systems will not be economical because more technology



development is needed to lower their capital costs. Technology costs and application benefits are very sensitive to the configuration of the storage system both in terms of discharge capacity (MW) and energy storage capacity (MWh). Independent system operators (ISOs), utilities, vendors and technology providers will need to actively shape evolving market rules and operational requirements to maximize storage cost-effectiveness. Ideally, markets and tariffs could be designed to take advantage of those benefits that can be provided by energy storage without adding unduly to system costs.

## Applications for Electric Energy Storage

Energy storage systems can provide a variety of application solutions along the entire value chain of the electrical system, from generation support to transmission and distribution support to end-customer uses. The 10 key applications that form the basis of EPRI's analysis are summarized in Table ES-1. *This list is not comprehensive.*

**Table ES-1**  
**Definition of Energy Storage Applications**

Value Chain	Application		Description
Generation & System-Level Applications	1	Wholesale Energy Services	Utility-scale storage systems for bidding into energy, capacity and ancillary services markets <sup>1</sup>
	2	Renewables Integration	Utility-scale storage providing renewables time shifting, load and ancillary services for grid integration
	3	Stationary Storage for T&D Support	Systems for T&D system support, improving T&D system utilization factor, and T&D capital deferral
T&D System Applications	4	Transportable Storage for T&D Support	Transportable storage systems for T&D system support and T&D deferral at multiple sites as needed
	5	Distributed Energy Storage Systems	Centrally managed modular systems providing increased customer reliability, grid T&D support and potentially ancillary services
	6	ESCO Aggregated Systems	Residential-customer-sited storage aggregated and centrally managed to provide distribution system benefits
	7	C&I Power Quality and Reliability	Systems to provide power quality and reliability to commercial and industrial customers
End-User Applications	8	C&I Energy Management	Systems to reduce TOU energy charges and demand charges for C&I customers
	9	Home Energy Management	Systems to shift retail load to reduce TOU energy and demand charges
	10	Home Backup	Systems for backup power for home offices with high reliability value
T&D = Transmission and Distribution; C&I = Commercial and Industrial; ESCO = Energy Services Company; TOU = Time of Use			

<sup>1</sup> This analysis modeled a larger unit providing both energy and ancillary services, and did not focus on a unit designed to provide regulation alone.

Additional energy storage applications exist now and others will emerge in the future, and will be the subject of future research. However, these 10 key applications represent the preponderance of energy storage uses and are of most interest to potential energy storage owners and operators.

Major stakeholder groups for energy storage systems include utilities, customers, independent system operators (ISOs), wholesale market participants including intermittent generators, retail service providers, ratepayers, regulators and policymakers.

Each of the 10 applications defined for this analysis centers around a specific operational goal but provides multiple benefits. Each benefit represents a discrete use of energy storage that can be quantified and valued. Due to the current high installed capital costs of most energy storage systems, applications (for either utilities or end users) must be able to realize multiple operational uses across different parts of the energy value chain, an aggregation of complementary benefits known as “stacking.” This concept is illustrated in Figure ES-5 for many of the energy storage functions served by the key applications.

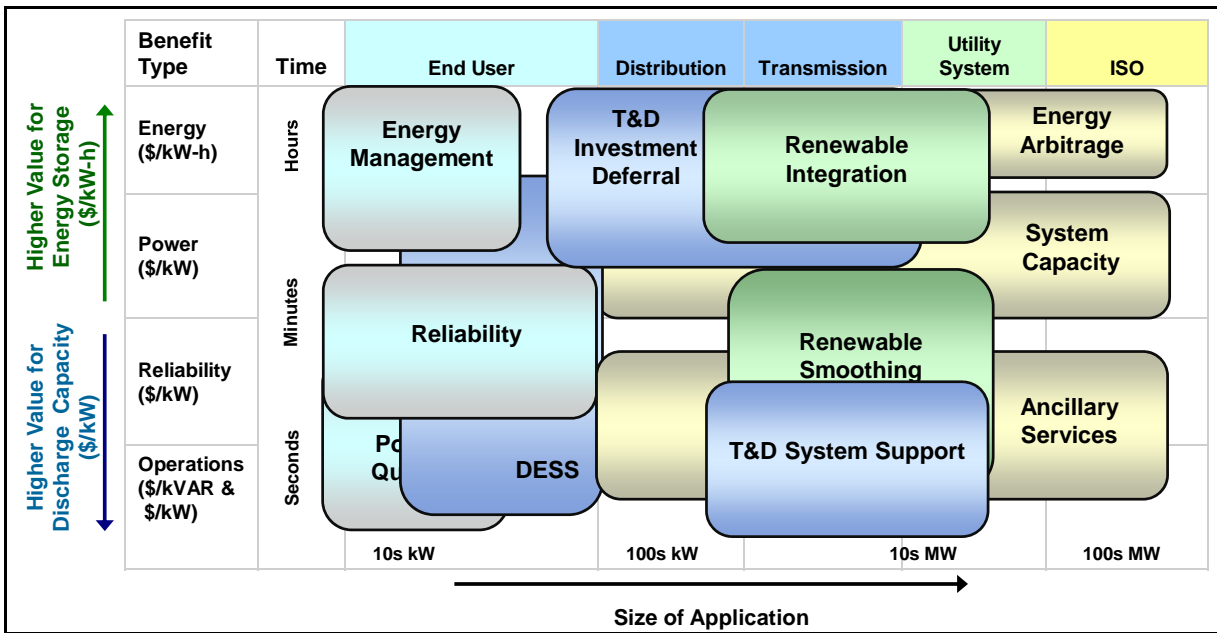

**Figure ES-5**  
Operational Benefits Monetizing the Value of Energy Storage

For purposes of comparison, Figure ES-6 illustrates the characteristics of various energy storage technology options in terms of system power rating along the X-axis and duration of discharge time at rated power on the Y-axis. For both figures, these comparisons are very general, intended for conceptual purposes only; many of the options have broader duration and power ranges than shown.

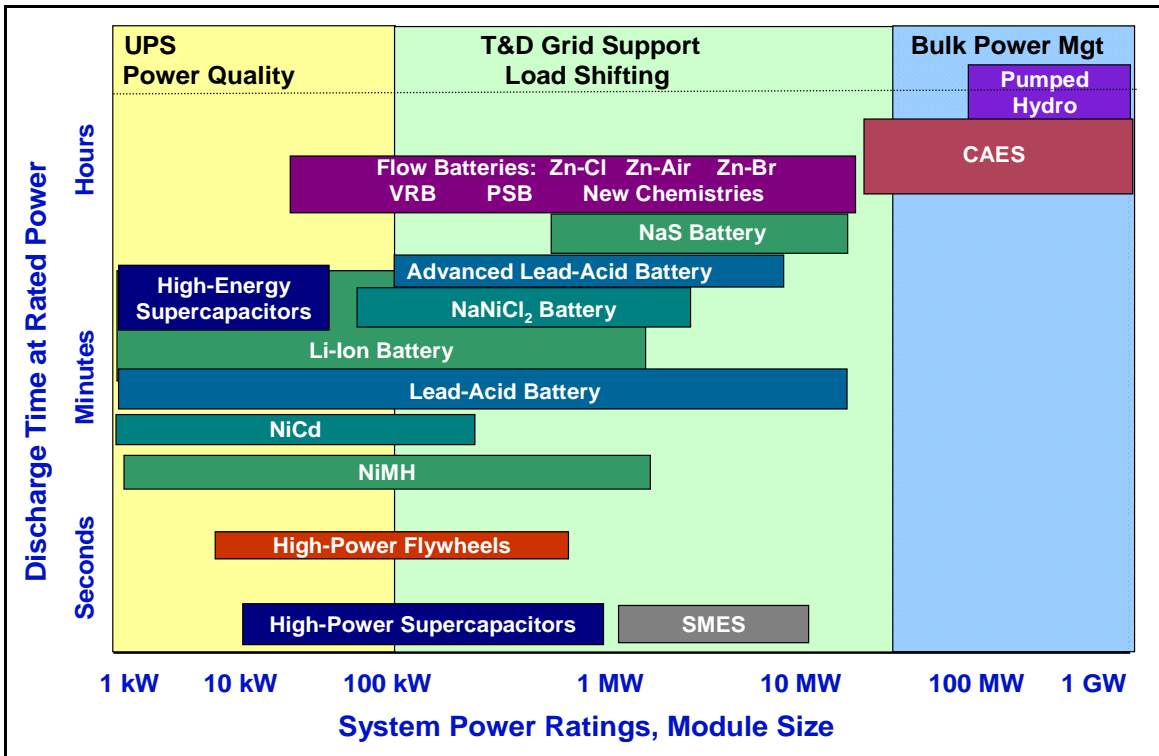

Figure ES-6  
Positioning of Energy Storage Technologies



Figure ES-7  
Commercial operation of a 12-MW frequency regulation and spinning reserve project at AES Gener's Los Andes substation in the Atacama Desert, Chile. The system uses A123 Systems' Li-ion Hybrid Ancillary Power Units (Hybrid-APUs™).

As emphasized previously, energy storage economics is highly dependent on the technology costs and potential revenues for both the discharge capacity (MW) and energy storage capacity (MWh). In covering a broad array of technologies, benefits, and applications, the relative importance of discharge capacity and energy delivery was considered in defining the size configuration and technologies modeled for each storage application. However, a detailed optimization incorporating technology costs, operational characteristics, and potential revenues to determine the best configuration for each technology and application was beyond the scope of this study. Furthermore, EPRI's modeling does not account for the difference in power delivery capability (inertia or momentum), response rates, or maximum ramp rates of storage systems, which will be important criteria for certain benefits such as ancillary services and renewables integration.



**Figure ES-8**  
**A 50-kWh BYD Li-ion Battery System Planned to be Tested at EPRI's Knoxville, Tenn. Smart Grid Laboratory in 2011.**

## **Energy Storage Application Requirements and Value of Benefits**

Table ES-2 (next page) provides an overview of the technical and energy storage performance requirements for the 10 energy storage applications with respect to size, duration, cycles and lifetime. These data are based on EPRI's generalized performance specifications and requirements, and are for the purposes of broad comparison only. System characteristics may vary greatly based on specific applications, site selection, and business environment. In the near future, EPRI's Energy Storage R&D Program will develop more detailed application requirements for market applications of interest to the utility sector.<sup>2</sup>

<sup>2</sup> *Functional Requirements for Electric Energy Storage Applications on the Power System Grid*, EPRI, Palo Alto, CA, 2010. 1020075.

**Table ES-2**  
**General Energy Storage Application Requirements <sup>1</sup>**

Application	Description	Size	Duration	Cycles	Desired Lifetime
Wholesale Energy Services	Arbitrage	10-300 MW	2-10 hr	300-400/yr	15-20 yr
	Ancillary services <sup>2</sup>	See Note 2	See Note 2	See Note 2	See Note 2
	Frequency regulation	1-100 MW	15 min	>8000/yr	15 yr
	Spinning reserve	10-100 MW	1-5 hr		20 yr
Renewables Integration	Wind integration: ramp & voltage support	1-10 MW distributed 100-400 MW centralized	15 min	5000/yr 10,000 full energy cycles	20 yr
	Wind integration: off-peak storage	100-400 MW	5-10 hr	300-500/yr	20 yr
	Photovoltaic Integration: time shift, voltage sag, rapid demand support	1-2 MW	15 min-4 hr	>4000	15 yr
Stationary T&D Support	Urban and rural T&D deferral. Also ISO congestion mgt.	10-100 MW	2-6 hr	300-500/yr	15-20 yr
Transportable T&D Support	Urban and rural T&D deferral. Also ISO congestion mgt.	1-10 MW	2-6 hr	300-500/yr	15-20 yr
Distributed Energy Storage Systems (DESS)	Utility-sponsored; on utility side of meter, feeder line, substation. 75-85% ac-ac efficient.	25-200 kW 1-phase 25-75 kW 3-phase Small footprint	2-4 hr	100-150/yr	10-15 yr
C&I Power Quality	Provide solutions to avoid voltage sags and momentary outages.	50-500 kW	<15 min	<50/yr	10 yr
		1000 kW	>15 min		
C&I Power Reliability	Provide UPS bridge to backup power, outage ride-through.	50-1000 kW	4-10 hr	<50/yr	10 yr
C&I Energy Management	Reduce energy costs, increase reliability. Size varies by market segment.	50-1000 kW Small footprint	3-4 hr	400-1500/yr	15 yr
		1 MW	4-6 hr		
Home Energy Management	Efficiency, cost-savings	2-5 kW Small footprint	2-4 hr	150-400/yr	10-15 yr
Home Backup	Reliability	2-5 kW Small footprint	2-4 hr	150-400/yr	10-15 yr

1. Size, duration, and cycle assumptions are based on EPRI's generalized performance specifications and requirements for each application, and are for the purposes of broad comparison only. Data may vary greatly based on specific situations, applications, site selection, business environment, etc.

2. Ancillary services encompass many market functions, such as black start capability and ramping services, that have a wide range of characteristics and requirements.

EPRI’s research further identified and modeled 21 benefits of energy storage (Table ES-3). For this analysis, the present value (PV) of benefits for each application was compared to the total costs of installing an energy storage system.

**Table ES-3  
Representative Benefit PVs of Selected Energy Storage Benefits (expressed as \$/kW-h and \$/kW)**

Value Chain	Benefit	PV \$/kW-h		PV \$/kW	
		Target	High	Target	High
End User	1 Power Quality	19	96	571	2,854
	2 Power Reliability	47	234	537	2,686
	3 Retail TOU Energy Charges	377	1,887	543	2,714
	4 Retail Demand Charges	142	708	459	2,297
Distribution	5 Voltage Support	9	45	24	119
	6 Defer Distribution Investment	157	783	298	1,491
	7 Distribution Losses	3	15	5	23
Transmission	8 VAR Support	4	22	17	83
	9 Transmission Congestion	38	191	368	1,838
	10 Transmission Access Charges	134	670	229	1,145
	11 Defer Transmission Investment	414	2,068	1,074	5,372
System	12 Local Capacity	350	1,750	670	3,350
	13 System Capacity	44	220	121	605
	14 Renewable Energy Integration	104	520	311	1,555
ISO Markets	15 Fast Regulation (1 hr)	1,152	1,705	1,152	1,705
	16 Regulation (1 hr)	514	761	514	761
	17 Regulation (15 min)	4,084	6,845	1,021	1,711
	18 Spinning Reserves	80	400	110	550
	19 Non-Spinning Reserves	6	30	16	80
	20 Black Start	28	140	54	270
	21 Price Arbitrage	67	335	100	500

Note: each benefit is modeled in isolation using a consistent battery configuration of 1 MW of discharge capacity and 2 MWh of energy storage capacity, with a 15-year life and a 10% discount rate. Here we introduce the nomenclature “\$/kW-h” used throughout this report. In this table it is the present value of the benefits divided by the useable kWh of the energy storage device.

This table shows the value of each individual benefit quantified in this analysis for purposes of a relative comparison only. Site-specific values may vary substantially from the figures presented here. The values for distribution deferral, transmission deferral, transmission congestion and price arbitrage are particularly variable and location specific. In addition, the values presented are not additive: the benefits must be modeled together in an integrated fashion, since providing some benefits in a particular hour will necessarily preclude others.

These estimates are analogous to the Total Resource Cost-effectiveness Test (TRC), which compares costs and benefits for a region as a whole regardless of who actually pays the cost or receives the benefits. For all but customer behind-the-meter applications, the benefits included in the TRC are also those that would be realized by a utility (no societal or environmental adders are included). Therefore, the benefit PVs for the wholesale and utility applications also represent the value of the storage device to a utility or ISO (Utility/Program Administrator Cost Test or UCT/PAC). Many other benefits or additional uses exist but are not modeled or quantified here.<sup>3</sup>

To provide a sense of their potential relative values, estimates are presented as “target” and “high” values. Target values represent an average value in the broader U.S. market for stakeholders who might consider investing in energy storage, while high values represent the value for premium or niche markets that place a particularly high value on the benefits provided by an energy storage system. As an example, for Power Reliability the target value is based on an average outage cost survey, whereas for the high value the 95th percentile is used.

## **Analytical Methodology and Key Conclusions**

In this analysis, the operation of each technology/application combination was simulated over the course of one year in a sequential hourly dispatch model. The technical specifications of the technology constrained the operations of the modeled storage device, accounting for charging and discharging capacity (in kW), energy storage capacity (kW-h), round-trip efficiency, and minimum depth of discharge, among other factors. Within those constraints, each energy storage device was dispatched based on expected prices to maximize revenue over the course of a day. Although other methods were explored, perfect foresight was used to provide the most consistent comparison of value across benefits and markets. For each application selected, ratios of discharge capacity to energy storage capacity were modeled.

The energy storage applications that achieve the highest revenues do so by aggregating several benefits across multiple categories. Using the example of Stationary T&D Support, under one scenario (Figure ES-9), a storage system provides end-user reliability benefits,

---

<sup>3</sup> Quantifying such benefits would require production simulation modeling of the regional transmission grid and generation portfolio, which is beyond the scope of this study.

distribution system support benefits, and system capacity. However, even with the aggregation of benefits across these three categories, the PV of benefits is estimated to be less than \$500/kW-h of energy storage.

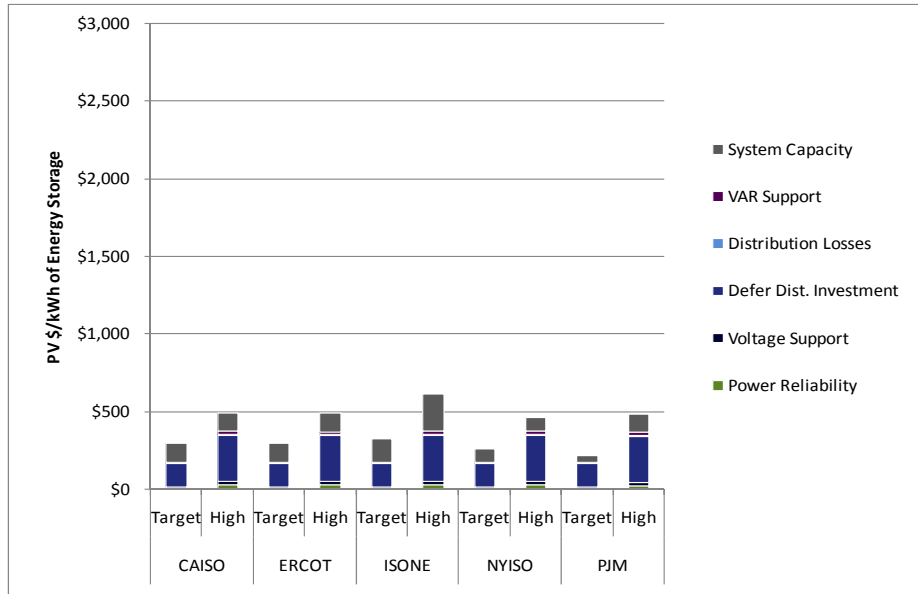

**Figure ES-9**  
Stationary T&D Deferral with No Ancillary Services

Under another scenario (Figure ES-10), the energy storage system also provides regulation services, is located in an area with local capacity requirements, and is able to potentially defer transmission investments. In this case, the PV of benefits increases dramatically. However, locations at which all of these benefits can be realized together are limited.

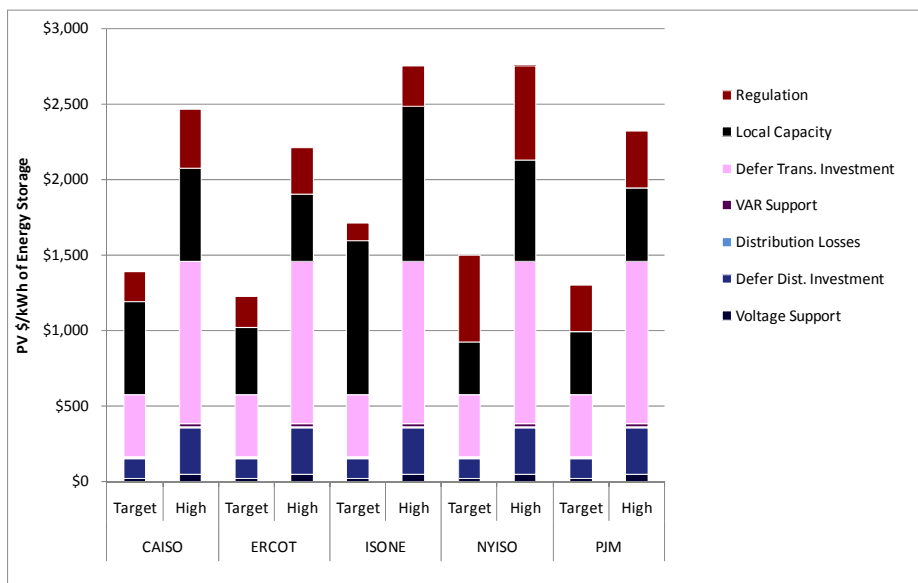

**Figure ES-10**  
Stationary T&D Deferral, with Regulation and Transmission Deferral



Figure ES-11 provides estimates for the total value for each of the 10 key energy storage applications examined. Applications that include end-user benefits were further broken out by customer class, for a total of 16 distinct application values.

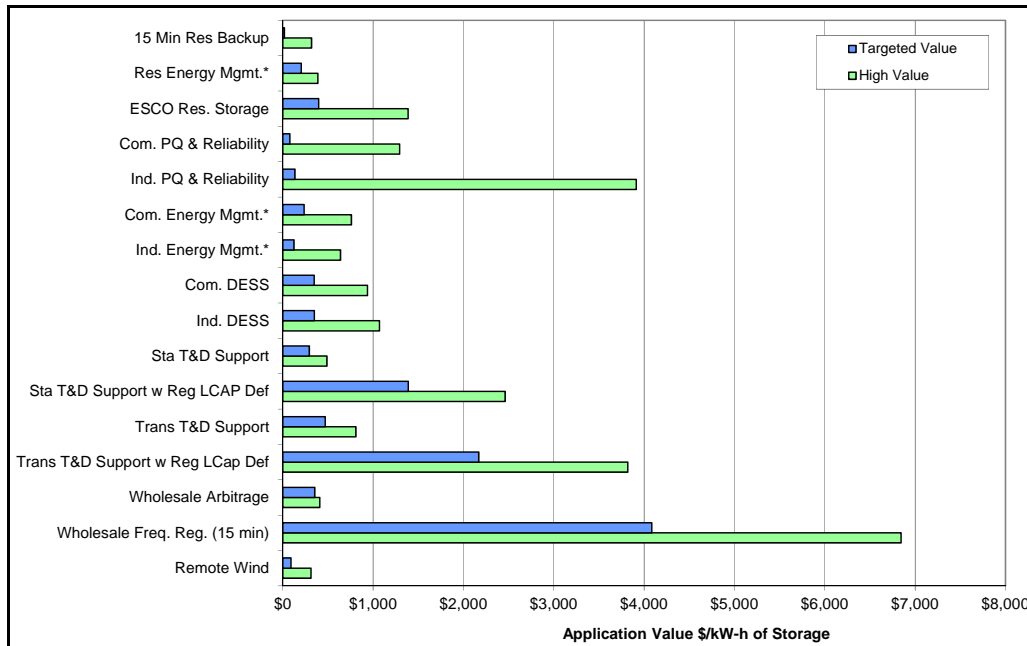

**Figure ES-11**  
Summary of Target and High Application PVs for Energy Storage

This figure shows the present value for the applications, which groups multiple benefits together. All values are presented from the regional (TRC) perspective except for the end-use energy management applications (*those applications in the figure with an asterisk*), which reflect the customer perspective and include bill savings that represent a loss of revenue to utilities.

As noted, energy storage applications that achieve the highest estimated revenues do so by aggregating several benefits across multiple categories. The analysis indicates that capturing multiple benefits—including transmission and distribution (T&D) deferral and ancillary services—will be critical for high-value applications. For reasons explained in the full report, the application values generated by EPRI’s models should be viewed as an upper bound of the total potential benefits.

## Market Size and Scale for Energy Storage in the United States

EPRI research in 2009 estimated the relative current U.S. market sizes for each energy storage application, and included estimates of technical market potential and a narrower “feasible” potential based on historic and estimated program adoption rates by end users and electric utilities (Figure ES-12).

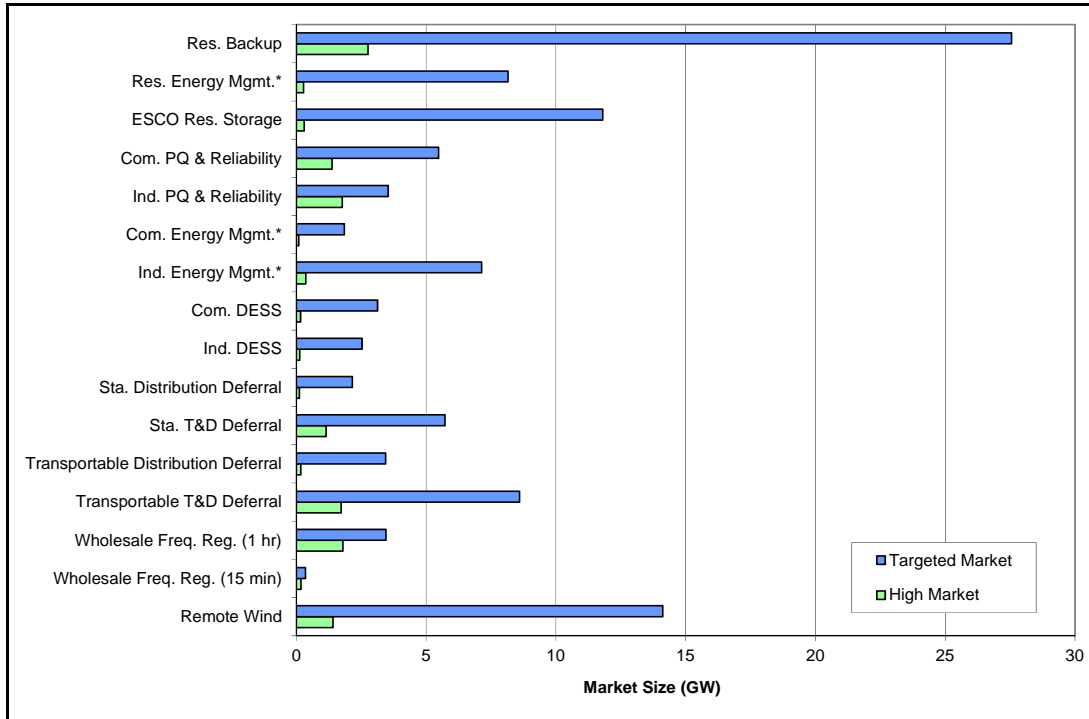

**Figure ES-12**  
**Targeted vs. High Value Market Size by Application**

As before, all values are presented from the regional (TRC) perspective except for the end-use energy management applications (*indicated in the figure with an asterisk*), which reflect the customer perspective and include bill savings that represent a loss of revenue to utilities.

The results presented here focus on currently defined markets only. The research did not estimate future applications or account for expansion or growth among current applications. It is also important to note EPRI’s preliminary market-sizing study does not take into account the cost effectiveness of the energy storage application, but is solely an analysis of the current individual market size for each application. Details on the methods used to estimate market sizes for each application are presented in Section 3 in the full report.

The size estimates do account for some overlap between markets, as each application includes multiple benefits and several applications will compete for the same markets. As a general rule, it is assumed that utility or wholesale applications and the applications with the highest PVs will have some advantages in capturing high-value benefits (for example, regulation services).

Figure ES-13 shows the results of combining the market size study and value analysis based on EPRI’s models. Target market size is on the x-axis and the application value in present value (PV) \$/kW-h is on the y-axis. The figure also provides insights on market

entry opportunities, as well as the total market size at particular price points. For example, at a price point of \$700/kW-h, the potential market size for energy storage is estimated to be approximately 14 GW.

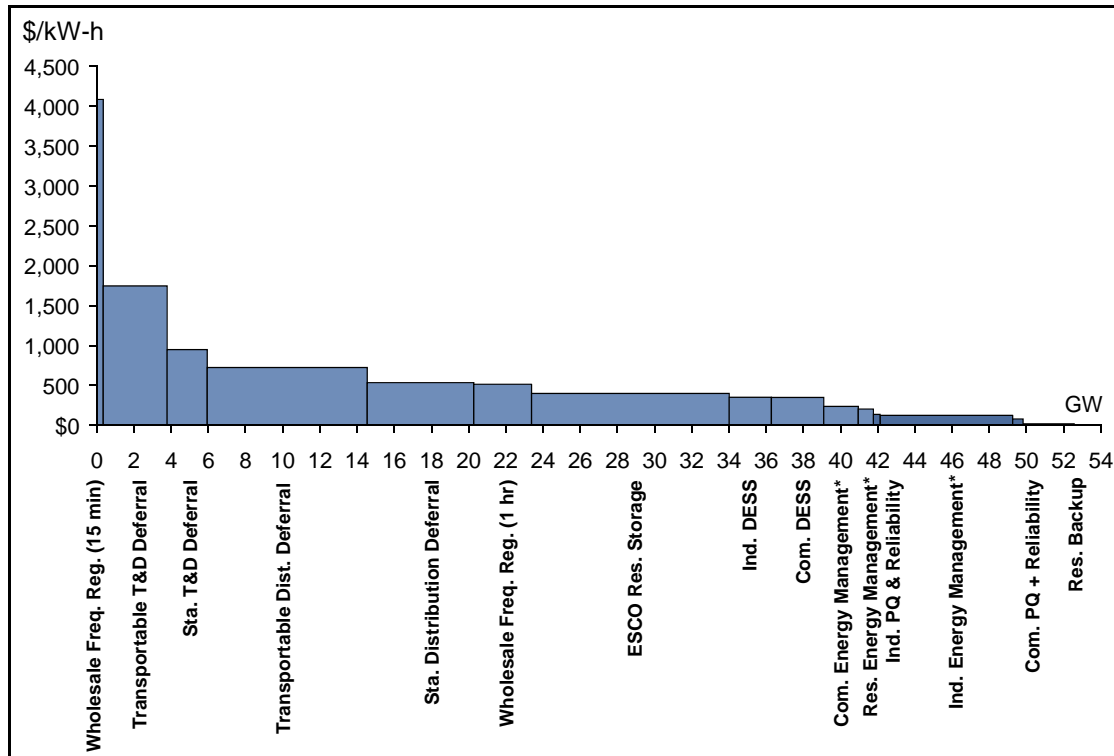

**Figure ES-13**  
Estimated Target Market Size and Target Value Analysis

### **Market Rules and Impact on Energy Storage Value**

Changing ISO market rules and product definitions have a potentially significant impact on the value of certain storage benefits. FERC Orders 890 and 719 required ISOs to modify their tariffs and market rules so all non-generating resources, such as demand response and energy storage, can fully participate in established markets alongside traditional generators. In response, ISOs are in various stages of implementing rule changes and pilot projects that will allow storage to provide 1 MW of regulation with as little as 15 minutes (or 250 kW-h) of energy delivery capacity.

To accommodate limited energy delivery and take advantage of faster response and ramp rates, some ISOs are also employing modified dispatch algorithms for non-generation or limited-energy resources. These modifications include providing a frequency-only-based signal (PJM), eliminating the requirement to bid regulation resources into the energy market (NYISO), active ISO control of the energy storage level to maximize regulation capacity (NYISO), dispatching fast-responding resources first (ISONE, NYISO) and providing mileage or pay-for-performance payments (ISONE). Energy-neutral dispatch and

compensation for fast response provide a particularly attractive opportunity for energy storage, which is often limited either by technology or economics in the amount of energy that can be provided. Implementing some of these modified rules has the potential to dramatically increase potential revenues on a \$/kW-h basis from roughly \$1,000/kW-h to over \$6,000/kW-h in some markets.

### **Future Markets**

Anticipated changes in future markets may also provide additional revenue potential for energy storage. Though the timing and magnitude of the impacts are difficult to predict, these changes include:

**Increased Volatility in Energy Prices:** Increasing penetration of wind generation is expected to increase the volatility of energy prices in several markets. Wind generation tends to peak during the night. In many regions, it will exert downward pressure on already lower off-peak energy prices. For example, the frequency of negative prices during off-peak periods in ERCOT has increased dramatically since 2006 as wind generation has increased. This volatility has the potential to improve energy arbitrage revenues from energy storage.

**Renewable Integration:** Multiple integration studies have suggested that the challenge of integrating renewables increases in a non-linear fashion as penetration levels exceed 20%. The CAISO *Integration of Renewable Resources* study<sup>4</sup> found that the maximum regulation-up requirement will increase 35% from 278 MW in 2006 to 502 MW in 2012 and then increase an additional 180% to 1,444 MW in 2020. The maximum load-following down-requirement is expected to roughly double from 2006 to 2012 over most of the year. It does not necessarily follow that prices will increase proportional to demand, however, as they are determined primarily by variable operating and fuel costs.

**High-Penetration Photovoltaic Generation:** Distribution engineers anticipate increasing challenges managing high penetrations of solar photovoltaics on the local distribution system. Energy storage systems can provide local voltage and VAR support, and manage intermittent variation in photovoltaic loads. These benefits will certainly have value where solar generation is concentrated on the distribution system, but that value is difficult to quantify as alternative strategies for managing concentrated photovoltaics are still being developed.

**Demand-Side Competition:** Demand response and other load-management strategies are also vying for the small but lucrative regulation market. The regulation market for the entire United States is less than 1% of industrial load. It is entirely possible that alternative load management technologies will saturate the regulation market even as the size of the

---

<sup>4</sup> *Integration of Renewable Resources: Operational Requirements and Generation Fleet Capability at 20% RPS*, California Independent System Operator: August 31, 2010.

market increases to meet wind integration. Load management could also potentially provide large quantities of the ramp and load following that will be required to integrate renewable generation. Load management opportunities are not necessarily dependent on AMI and smart grid networks, but could be significantly enhanced by their deployment.

**Commercial and Energy Management:** In addition to the markets discussed in this report, future markets could emerge with the replacement of existing back-up generation, large UPS systems, or co-location with high-efficiency distributed generation systems such as fuel cells. As lower cost energy storage systems develop, these markets and applications could emerge and create new channels for adopting embedded energy storage systems.

## **Energy Storage System Costs**

The current status of energy storage technology options and updated estimated ranges for their total installed costs, performance, and availability for key applications are presented below. Estimates are based on technology assessments, discussions with vendors and utilities, and experience with operating systems. The estimates include process and project contingencies to account for technology and application uncertainties. Tables ES-4 and ES-5 provide estimates by application for megawatt-scale and kilowatt-scale energy storage systems, respectively. Distributed energy storage systems smaller than 100 kW are sometimes called “community energy storage systems.” *See the full report for important explanations and assumptions regarding data presented in these tables.*

**Table ES-4**  
**Energy Storage Characteristics by Application (Megawatt-scale)**

Technology Option	Maturity	Capacity (MWh)	Power (MW)	Duration (hrs)	% Efficiency (total cycles)	Total Cost (\$/kW)	Cost (\$/kW-h)
<b>Bulk Energy Storage to Support System and Renewables Integration</b>							
Pumped Hydro	Mature	1680-5300	280-530	6-10	80-82 (>13,000)	2500-4300	420-430
		5400-14,000	900-1400	6-10		1500-2700	250-270
CT-CAES (underground)	Demo	1440-3600	180	8	See note 1 (>13,000)	960	120
				20		1150	60
CAES (underground)	Commercial	1080	135	8	See note 1 (>13000)	1000	125
		2700		20		1250	60
Sodium-Sulfur	Commercial	300	50	6	75 (4500)	3100-3300	520-550
Advanced Lead-Acid	Commercial	200	50	4	85-90 (2200)	1700-1900	425-475
	Commercial	250	20-50	5	85-90 (4500)	4600-4900	920-980
	Demo	400	100	4	85-90 (4500)	2700	675
Vanadium Redox	Demo	250	50	5	65-75 (>10000)	3100-3700	620-740
Zn/Br Redox	Demo	250	50	5	60 (>10000)	1450-1750	290-350
Fe/Cr Redox	R&D	250	50	5	75 (>10000)	1800-1900	360-380
Zn/air Redox	R&D	250	50	5	75 (>10000)	1440-1700	290-340
<b>Energy Storage for ISO Fast Frequency Regulation and Renewables Integration</b>							
Flywheel	Demo	5	20	0.25	85-87 (>100,000)	1950-2200	7800-8800
Li-ion	Demo	0.25-25	1-100	0.25-1	87-92 (>100,000)	1085-1550	4340-6200
Advanced Lead-Acid	Demo	0.25-50	1-100	0.25-1	75-90 (>100,000)	950-1590	2770-3800
<b>Energy Storage for Utility T&amp;D Grid Support Applications</b>							
CAES (aboveground)	Demo	250	50	5	See note 1 (>10,000)	1950-2150	390-430
Advanced Lead-Acid	Demo	3.2-48	1-12	3.2-4	75-90 (4500)	2000-4600	625-1150
Sodium-Sulfur	Commercial	7.2	1	7.2	75 (4500)	3200-4000	445-555
Zn/Br Flow	Demo	5-50	1-10	5	60-65 (>10,000)	1670-2015	340-1350
Vanadium Redox	Demo	4-40	1-10	4	65-70 (>10,000)	3000-3310	750-830
Fe/Cr Flow	R&D	4	1	4	75 (>10000)	1200-1600	300-400
Zn/air	R&D	5.4	1	5.4	75 (4500)	1750-1900	325-350
Li-ion	Demo	4-24	1-10	2-4	90-94 (4500)	1800-4100	900-1700

Technology Option	Maturity	Capacity (MWh)	Power (MW)	Duration (hrs)	% Efficiency (total cycles)	Total Cost (\$/kW)	Cost (\$/kW-h)
<b>Energy Storage for Commercial and Industrial Applications</b>							
Advanced Lead-Acid	Demo-Commercial	0.1-10	0.2-1	4-10	75-90 (4500)	2800-4600	700-460
Sodium-Sulfur	Commercial	7.2	1	7.2	75 (4500)	3200-4000	445-555
Zn/Br Flow	Demo	0.625	0.125	5	60-63 (>10000)	2420	485-440
		2.5	0.5	5		2200	
Vanadium Flow	Demo	0.6-4	0.2-1.2	3.5-3.3	65-70 (>10000)	4380-3020	1250-910
Li-ion	Demo	0.1-0.8	0.05-0.2	2-4	80-93 (4500)	3000-4400	950-1900

**Table ES-5  
Energy Storage Characteristics by Application (Kilowatt-scale)**

Technology Option	Maturity	Capacity (kWh)	Power (kW)	Duration (hrs)	% Efficiency (total cycles)	Total Cost (\$/kW)	Cost (\$/kW-h)
<b>Energy Storage for Distributed (DESS) Applications</b>							
Advanced Lead-Acid	Demo-Commercial	100-250	25-50	2-5	85-90 (4500)	1600- 3725	400- 950
Zn/Br Flow	Demo	100	50	2	60 (>10000)	1450-3900	725-1950
Li-ion	Demo	25-50	25-50	1-4	80-93 (5000)	2800-5600	950-3600
<b>Energy Storage for Residential Energy Management Applications*</b>							
Lead-Acid	Demo-Commercial	10	5	2	85-90 (1500-5000)	4520-5600	2260
		20		4			1400
Zn/Br Flow	Demo	9-30	3-15	2-4	60-64 (>5000)	2000-6300	785- 1575
Li-ion	Demo	7-40	1-10	1-7	75-92 (5000)	1250- 11,000	800-2250
<ol style="list-style-type: none"> <li>1. Refer to the full EPRI report for important key assumptions and explanations behind these estimates. All systems are modular and can be configured in both smaller and larger sized not represented. Figures are estimated ranges for the total capital installed cost estimates of "current" systems based on 2010 inputs from vendors and system integrators. Included are the costs of power electronics if applicable, all costs for installation, step-up transformer, and grid interconnection to utility standards. Smart-grid communication and controls are also assumed to be included. For batteries, values are reported at rated conditions based on reported depth of discharge. Costs include process and project contingency depending on technical maturity. The cost in \$/kW-h is calculated by dividing the total cost by the hours of storage duration.</li> <li>2. For CAES and Pumped Hydro, larger and smaller systems are possible. For belowground CAES the heat rate may range from ~3845-3860 Btu/kWh and the energy ratio is 0.68-0.78; for aboveground CAES the heat rate is ~4000 Btu/kWh and the energy ratio is ~1.0.</li> <li>3. For C&amp;I and Residential applications lower CapEx costs may be possible if the battery system is integrated and installed with a photovoltaic system.</li> <li>4. First-of-a-kind system costs will be higher than shown. Future system costs may be lower than shown after early demonstrations are proven and products become standardized.</li> </ol>							

Note that the technological and commercial maturity of these energy storage technologies also varies greatly. Some systems, such as lead-acid batteries and sodium sulfur batteries, are proven technologies with many years of experience while others, such as flow batteries and emerging Li-ion batteries, are newer and have limited operational field experience. Technology maturity and risk are important variables that are discussed in the full report.

Also, while capital cost is an important planning metric, a life-cycle cost analysis and or a comparison of cost per delivered kilowatt-hour over the project life will be an equally important business case evaluation metric.

### Gap Analysis

The total installed energy storage system costs presented in Tables ES-4 and ES-5 reflect the near-term energy storage technology system costs and input assumptions that were considered when evaluating storage technologies for their fit with the applications addressed in the analysis. Costs and technology characteristics, including operating restrictions for each storage technology, were used to assess current “gaps” between cost and value. Estimates of installed capital cost for the energy storage systems expected to be available within the next 1 to 5 years were obtained from vendors, OEMs and system integrators, and include uncertainties in performance as well as durability and contingency as estimated by EPRI. While site-specific conditions and application specific requirements may cause actual costs to vary for each technology, a summary of the technology gap analysis is presented in Figure ES-14, with values expressed in terms of \$/kW-h of energy storage capacity.

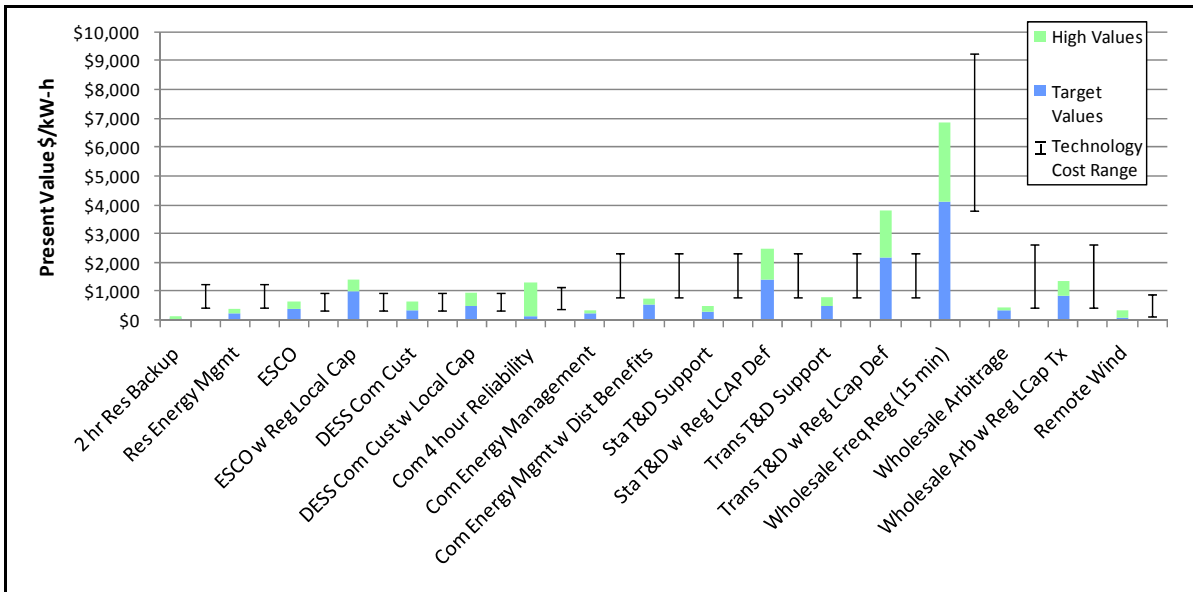

**Figure ES-14**  
**Application Value and System Cost Gap for All Technologies**

The figure compares each energy storage application to the range of available energy storage technologies and shows that some applications, such as residential backup power, appear currently uneconomical for all of the technologies examined. For other applications, such as a transportable storage systems that can provide T&D support while also serving regulation and local capacity, the application values exceed storage technology costs. For still other applications, such as commercial reliability, there may be economical storage



applications only for customers that receive high benefit values, such as a commercial data center.

EPRI research indicates that in the near term some storage technology costs could decrease significantly as the electric vehicle industry ramps up battery production. Also in the near term, underground compressed air energy storage (CAES) and pumped hydro systems are found to be the lowest cost in terms of \$/kW-h, with the primary constraint being identifying developable sites, environmental permitting, and available near transmission assets. Advanced lead-acid batteries, Zn/Br flow batteries and emerging Zn/air and Fe/Cr were generally found to have potential for low capital expenditure and the smallest gaps to support the energy storage business case for battery technologies. Also, aboveground CAES may offer attractive capital expenditure in suitable siting applications. Li-ion batteries, with the most significant cost reductions anticipated via increasing production capacity, could potentially prove competitive for a number of applications in the near and longer term for energy durations less than 4 hours.

## **Levelized Costs of Delivered Energy and Capacity**

An alternative basis for comparing different energy technologies is to divide the total costs to construct, finance, operate and maintain a plant by its useful output. The costs are levelized using the cost of capital or discount rate to calculate a flat cost for energy (\$/kWh) and capacity (\$/kW-yr) over the life of the plant. Levelized cost of delivered energy or capacity provides a useful metric to compare the costs of technologies with different useful lives, efficiencies, and capacity factors on a fair basis.

For generation assets, the primary basis for comparison is the levelized cost of energy in \$/kWh. The cost or value of capacity is levelized on an annual basis and expressed as \$/kW-yr. Capacity cost represents the cost of a plant being available to provide electric generation whether or not it actually operates, analogous to an insurance premium. Although the primary purpose of a capacity asset is to provide energy when needed during peak demand periods or system outages, it can also earn revenue in energy and ancillary service markets throughout the year when it is economical to do so.

Therefore, when calculating the cost or value of capacity, the net revenues (or net margins) earned from other markets are first subtracted from the full cost of the plant. This results in a residual capacity value. ISOs such as PJM, NYISO and CAISO calculate the residual capacity value of a combustion turbine to establish the “Cost of New Entry” (CONE). The CONE represents the additional payments needed over and above energy and ancillary service market revenues to provide sufficient incentive for a developer to construct and operate a new plant in the region.

Figure ES-15 shows the levelized cost of delivered energy (in \$/kWh) for energy storage technologies providing T&D Grid Support and Renewable Integration/Time Shifting using the low and high costs and efficiencies from Table ES-4. Annual O&M cost estimates are also included for both the low and high cost cases, but are highly uncertain given limited

data and operational experience. These costs are then compared to the cost of energy generated by a combined-cycle gas turbine (CCGT). The energy storage costs are calculated assuming one full cycle per day (except for industrial lead-acid batteries with 2,200 cycles) with an off-peak charging cost of \$30/MWh. Most technologies are compared over a 20-year lifetime for the low-cost case and a 15-year lifetime for the high-cost case (See tables A-22 through A-25 in the Appendix). That is not to say that the expected lifetime of each storage technology is 15–20 years. Assumptions are made for each technology and then leveled based on the methodology presented in the full report.

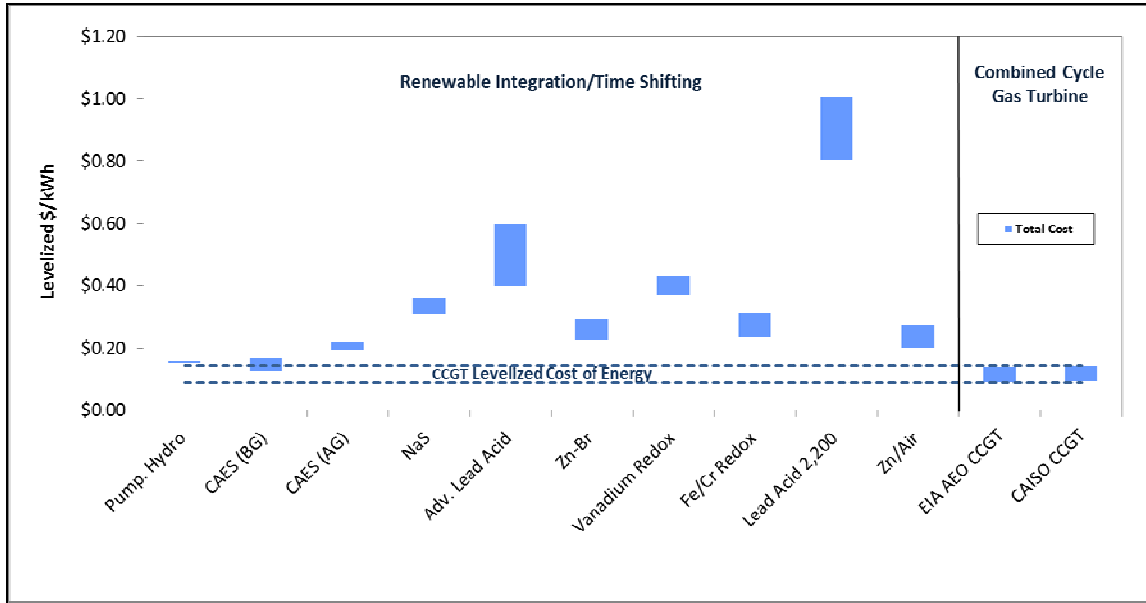

**Figure ES-15**  
**Levelized Cost of Delivered Energy for Energy Storage Technologies Compared to CCGT.**

Figure ES-16 shows the levelized total and residual capacity cost (in \$/kW-yr) for technologies providing Frequency Regulation and T&D Grid Support using the low and high costs and efficiencies from Table ES-4. These costs are compared to the total and residual capacity value for a combustion turbine calculated by PJM, NYISO and CAISO, respectively. Frequency Regulation assumes mileage of 0.18 kWh of energy per kW of regulation bid. The nature of the charge and discharge cycles required for frequency regulation is difficult to characterize accurately and not incorporated in this analysis. It is assumed that cycle life is not a limiting factor for this application, but that may not be true for all locations or technologies. T&D Grid Support assumes one full cycle per day (except for industrial lead-acid with 2,200 cycles). All applications assume a charging cost of \$30/MWh. For T&D Grid Support, as for a combustion turbine, a residual capacity value is calculated by subtracting potential energy and ancillary service revenues. All costs are leveled over the assumed useful life of the storage technology with an after-tax weighted-average cost of capital (WACC) of 10.46%. Additional assumptions include a leveled low and high natural gas cost of \$6.50 and \$8.00/MMBtu and a carbon price of \$30/ton.

Tables with a complete list of assumptions used for each technology are shown starting in Table A-21 in the Appendix of the full report.

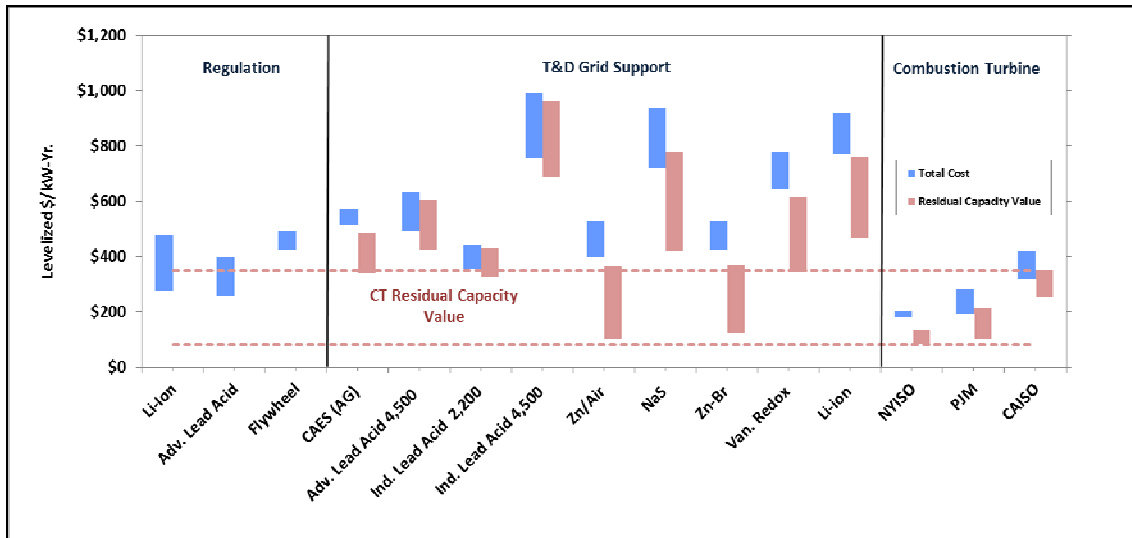

**Figure ES-16**  
Levelized Total and Residual Capacity Cost for Storage Technologies Compared to Combustion Turbine

## Conclusions

This paper presents some of the key findings of EPRI’s Energy Storage Program, which should advance the understanding of the value and benefits of energy storage in various applications. Information, estimates, and data presented in this paper will be of value to utility system planners, strategic planners, and managers dealing with wind and photovoltaic integration, grid support investments, and smart grid programs. Results can form a foundation aiding the prioritizing of follow-on energy storage analysis, development and demonstration initiatives, and targeted energy storage solution projects.

The analysis summarized in this paper indicates that capturing multiple benefits—including transmission and distribution (T&D) deferral, local or system capacity, and frequency regulation—is key for high-value applications. Applications that achieve the highest revenues do so by aggregating several benefits across multiple categories.

When end-user reliability, distribution system support, and system capacity benefits are aggregated in a T&D support application, the present value range of benefits is estimated to be less than \$500/kW-h of energy storage for ISO markets modeled. For the same application, if the energy system is able to provide regulation, is located in an area with local capacity requirements, and is able to defer transmission investments, our analysis estimates that the present value of benefits ranges from \$1228–\$2755/kW-h of energy storage. However, the number of locations at which all of these benefits can be realized together is limited.

Based on EPRI's models, the highest value applications from a regional or Total Resource Cost (TRC) perspective are:

- Wholesale Services with Regulation (15 minutes)
- Commercial and Industrial Power Quality and Reliability
- Stationary and Transportable Systems for Grid Support and T&D deferral.

Applications that provide high value to some end-use customers include:

- Commercial, Industrial, or Home Energy Management
- Commercial and Industrial Reliability and Power Quality.

The results presented imply that, based on the broader U.S. benefits of storage (target values), the total energy storage market opportunity is on the order of 14 GW if energy storage systems could be installed for about \$700–\$750/kW-h and the benefits estimated could all be monetized. Actual installed costs would need to be lower to accommodate life-cycle impacts and maintenance. Niche high-value market sizes were estimated to total approximately 5 GW if energy storage systems could be installed for \$1400/kW-h and all benefits could be monetized.

The operational and market rules under which storage will ultimately operate will have a significant impact on the high benefit values identified in this report. T&D grid support benefits are highly location-specific, and will depend on the support of utility engineers and operators for alternative grid management and protection strategies. Likewise, the market rules and tariffs adopted by utilities and ISOs will have a significant impact on market revenues, particularly for the comparatively lucrative regulation market.

In the near term, compressed air energy storage (CAES) systems, advanced lead-acid batteries, and Zn/Br flow batteries were generally found to have the smallest gap to support the business case based on regional benefits. However, specific applications and sites may vary, and a life-cycle cost and benefit analysis will be required to support a specific application business case.

### ***Policy Implications***

Several policy challenges need to be resolved to realize the true potential of storage assets. Energy storage systems have multi-functional characteristics, which complicates rules for ownership and operation among various stakeholders. Regulatory agencies have not defined ownership structures and flexible business models in which storage can be used for both generation and grid uses. Policy rules regarding allocation of costs incurred by adding storage systems to the grid need to be more clearly developed. Energy storage could enable bi-directional energy flows, creating potential problems for current tariff, billing and metering approaches.

No single storage system can meet all of the application needs of the power grid, and a wide variety of storage technology options are being proposed for utility-scale storage uses. EPRI research has identified leading energy storage candidates for near-term demonstrations: compressed air energy storage (CAES), which is currently the most cost-effective bulk storage technology for long discharge (more than 10 hours) durations, and lithium-ion batteries, which could potentially be the most cost-effective option in the long term for short durations (less than 4 hours). Selected flow batteries, advanced lead-acid batteries, and emerging storage options which show promise for 4- to 8-hour duration should also be tested and demonstrated.

The market rules and tariffs under which storage will operate are still in the early stages of development. Additional certainty in this area would remove a barrier to storage adoption. The results of this research should help inform the development of new market structures and rules to accommodate and reap the benefits of emerging energy storage systems.

### ***Role for Electric Utilities***

Electric utilities are uniquely positioned to support energy storage applications because they can test, evaluate and deploy applications in different sections of the electricity value and supply chain, and ultimately monetize the benefits of the various applications. No single energy storage option meets every need for the applications identified. Instead, a portfolio of storage options that meet the cost, performance and durability requirements will be needed. Utilities can use the results of this analysis to assess and value the application business case. High-value markets identified can help focus future demonstration activities to advance the deployment and adoption of energy storage systems.

EPRI's analysis indicates that market or policy rules to accommodate new storage services could also have a significant impact on the allowable costs of energy storage systems. Key market definition issues for energy storage are minimum energy delivery requirements, energy-neutral dispatch, premium values for fast and accurate response, minimum size, and aggregation rules. Research also identified several policy challenges that are limiting the true potential of energy storage:

- Energy storage systems' multi-functional characteristics complicate rules for ownership and operation among various stakeholders.
- Regulatory agencies have not defined ownership structures through which storage can be used for both generation and grid uses. In some jurisdictions, a grid asset may not participate in wholesale energy markets.
- Policy rules regarding allocation of costs incurred by adding storage systems to the grid need to be more clearly developed.

- Energy storage could enable bi-directional energy flows, creating problems for existing tariff, billing and metering approaches.
- New market structures and rules may be needed to accommodate and reap the benefits of emerging energy storage systems.

### Recommendations

Many of the energy storage options discussed have not been validated in the applications discussed, and are not “grid-ready.” Figure ES-17 presents a near-term roadmap to achieve grid-ready storage solutions by 2015.

Industry stakeholders should develop a blueprint action plan and roadmap for advancing the market integration of energy storage solutions within the electric enterprise. A potential framework for, and possible elements of, such an action plan are discussed in the full report. Working with its member utilities and industry stakeholders, EPRI will collaborate to advance the deployment and grid integration of energy storage solutions for key applications that offer high near-term value to the electric enterprise. EPRI’s goal is to enable and achieve grid-readiness of energy storage solutions by 2015.

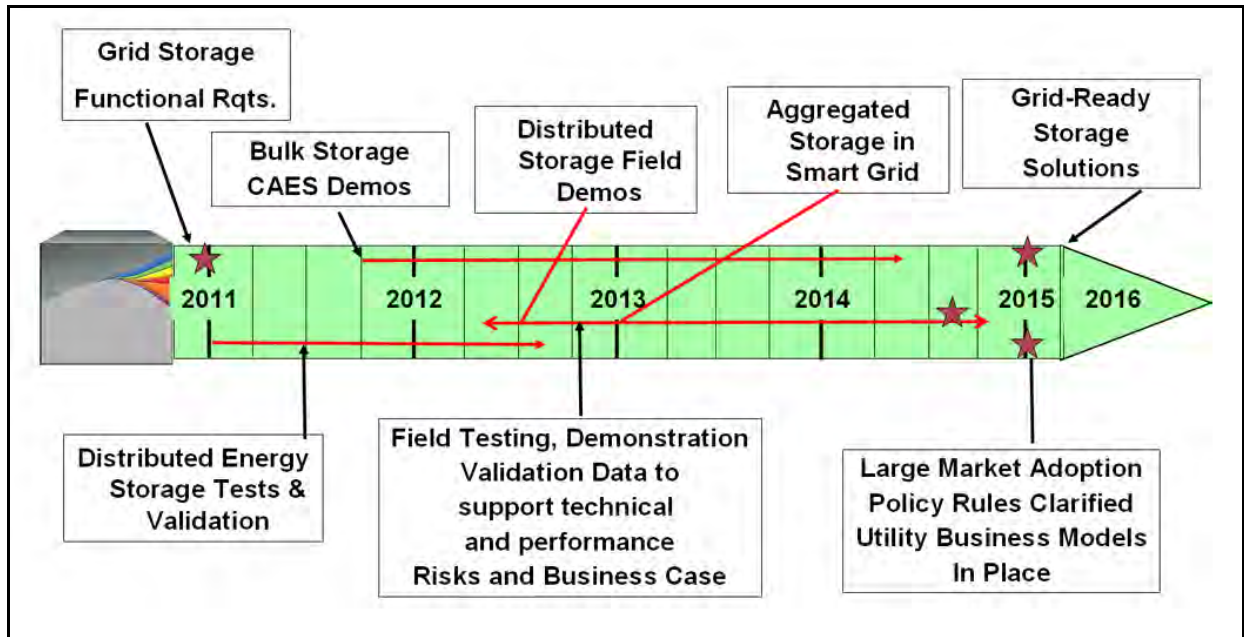

Figure ES-17  
Grid-Ready Energy Storage Roadmap

# 1 INTRODUCTION

---

## Purpose

A confluence of industry drivers—including increased deployment of renewable generation, costs for managing grid peak demands, and capital investments in grid infrastructure for reliability and smart grid initiatives—is creating a new interest in electric energy storage systems. A few storage systems are currently available and “grid-ready,” while others are still in the R&D pipeline positioned to provide industry solutions. The goal of this white paper is to inform industry executives, policymakers, and other industry stakeholders of the status of current and emerging trends in electric energy storage systems. This information focuses on energy storage markets, applications, value, and costs. The current portfolio of energy storage options is reviewed to provide information for electric utilities, government agencies, and industry stakeholders.

In producing this report, EPRI’s Energy Storage Program drew on information from technology assessments, market analysis, application assessments, and input from storage system vendors and system integrators. The paper provides an overview of energy storage applications and technology options, including updated cost and performance estimates for current and near-term options. Longer-term emerging systems are also highlighted. A final goal of this paper is to outline a framework and methodology that electric utilities and industry stakeholders may use in estimating the value of energy storage systems in the following applications:

- Photovoltaic integration
- Wind power integration
- System applications
- Utility transmission and distribution (T&D) asset management
- Commercial and industrial (C&I) applications
- Distributed energy storage near end-user loads
- Residential applications.

For each application area, the report presents an overview of the application and relevant energy storage solution options, including:

- A brief description of the technologies
- A summary of technology development status

---

*Introduction*

- Current technology performance and costs, including uncertainties
- Comparative benefit and gap analysis by application
- Major technical issues and future development direction and trends
- Development and commercialization timelines
- Relevant market adoption and business issues
- A framework for economic value analysis.

While the information in this paper is generic and is not tailored to utility or system site-specific studies, it provides baseline information with appropriate qualitative references to site-specific conditions that may have an impact on estimates of cost and value.

## Background

Electric energy storage systems have applications along the entire electric enterprise value chain, as illustrated in Figure 1-1.

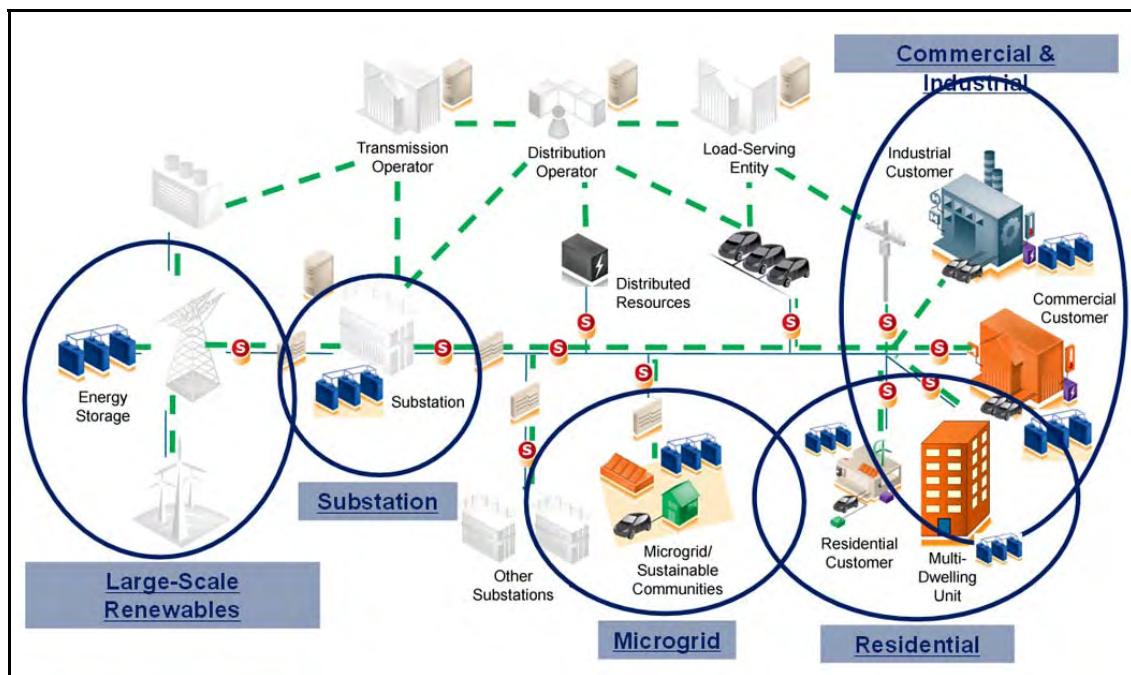

**Figure 1-1**  
**Electric Energy Storage within the Electric Enterprise (Courtesy of PG&E)**

Bulk energy storage systems are positioned within the high-voltage transmission system (115 kVA–230 kVA) and are in the domain of the independent system operator (ISO),



independent power producer (IPP), and vertically integrated utility. Key market drivers include:

- Enabling more penetration of intermittent renewable resources such as wind and solar power on the system, thereby helping reduce the electricity sector's carbon footprint and satisfy regulatory requirements such as renewable portfolio standards (RPSs)
- Balancing supply and demand by providing ancillary services, especially frequency regulation support
- Responding quickly to system contingencies such as equipment failure or power plant outages
- Balancing load and relieving transmission congestion
- Smoothing or avoiding cycling of thermal power plants being used for frequency regulation, or for load following, especially during off-peak conditions.

Distributed energy storage systems fall within city load centers (< 69 kVA) at electric utility substations, near feeders, within neighborhoods, and at industrial, commercial, and residential customer locations. Such storage systems can be located on either the utility or customer side of the meter. Market drivers include:

- Managing electric grid peak demands
- Improving reliability and outage mitigation
- More effectively using capital expenditures for new grid infrastructure
- Accommodating distributed renewables and plug-in electric vehicles
- Increasing electric grid load factor and utilization via the smart grid.

There are a variety of potential energy storage options for the electric sector, each with unique operational, performance, and cycling and durability characteristics. Figure 1-2 provides comparative estimates of total current installed capacity worldwide.

While many forms of energy storage have been installed, pumped hydro systems are by far the most widely used, with more than 127,000 megawatts (MW) installed worldwide. Compressed air energy storage (CAES) installations are the next largest with 440 MW, followed by sodium-sulfur batteries with approximately 316 MW, representing 1896 megawatt-hours (MWh) deployed on 221 sites. In addition, there are ~606 MW (3636 MWh) of sodium-sulfur projects planned or announced worldwide. All remaining energy storage resources worldwide total less than 85 MW combined, and consist mostly of a few one-off installations.

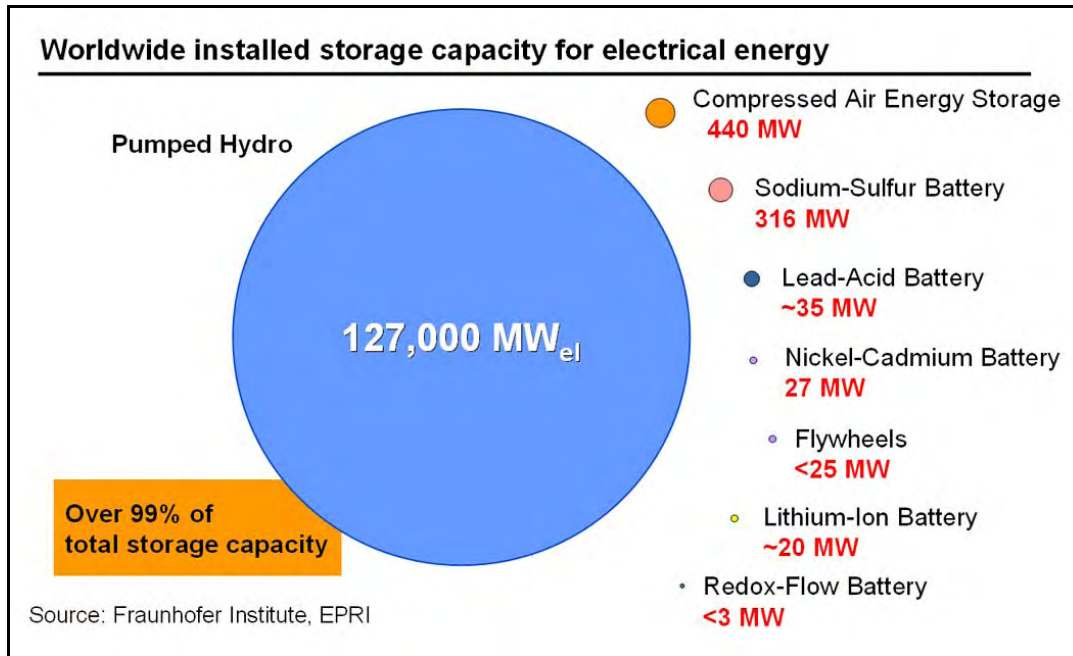

**Figure 1-2**  
**Worldwide Installed Storage Capacity for Electrical Energy**

Despite the large anticipated need for energy storage solutions within the electric enterprise, very few grid-integrated storage installations are in actual operation in the United States today, particularly in the applications described in this report. This landscape is expected to change around 2011, when a host of new storage options supported by more than \$250 million in U.S. stimulus funding begin to emerge and, in turn, catalyze a portfolio of new energy storage demonstrations. Such tests in real-world trials will provide needed data and information on the robustness of such systems, including performance and durability, cycle life costs, and risks. These data will be essential in advancing the learning for grid integration and application values detailed in this report. Figure 1-3 illustrates a few of the key demonstrations planned which, if successful, will contribute to the technical readiness and further adoption of storage solutions by 2015.

Each type of energy storage technology has its own capital cost and operating cost parameters, which are described elsewhere in this paper. In general, based on present-day technology, some energy storage systems will not be cost effective since more technology development is needed to lower the capital costs of such storage plants. Technology costs and application benefits are very sensitive to the configuration of the storage system both in terms of discharge capacity (MW) and energy storage capacity (MWh). Independent system operators (ISOs), utilities, vendors and technology providers will need to actively shape evolving market rules and operational requirements to maximize storage cost-effectiveness. Ideally, markets and tariffs could be designed to take advantage of those benefits that can be provided by energy storage without adding unduly to system costs.

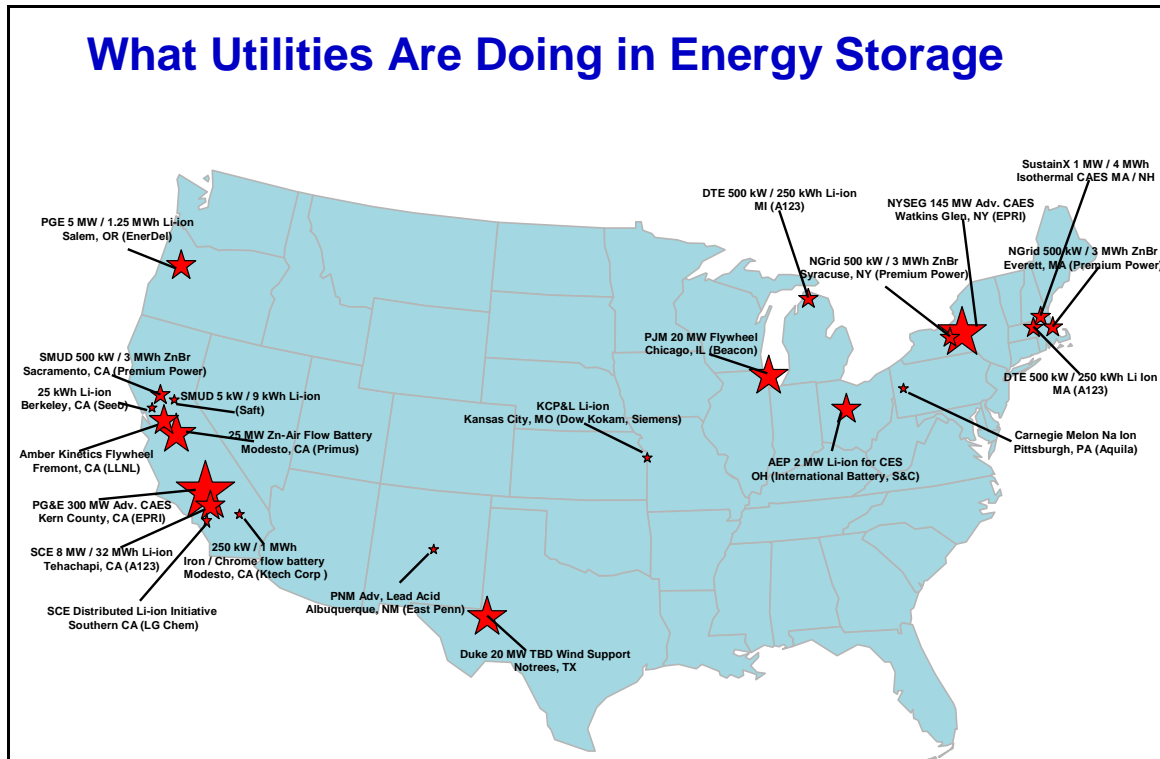

**Figure 1-3**  
Map of ARRA-Funded Energy Storage Projects

## Expectations

The objective of this paper is to provide information and data that are timely, applicable to planning, and of regulatory quality. This last term implies that data pass the “sanity checks and scrutiny” that regulatory bodies are likely to require for representations of the cost or performance of both existing and future technologies. In this context, the design basis, cost estimate basis, and economic basis are linked together to estimate an installed capital costs per kilowatt (\$/kW) and cost per kilowatt-hour (\$/kW-h) of delivered energy over the life of the system. For technology-screening-level studies, these cost estimates are conceptual estimates that will differ from site-specific project estimates for a number of reasons:

- Project estimates are more detailed and based on site-specific conditions.
- Individual companies’ design bases may vary.
- Actual owner costs as well as site-specific costs in project estimates are generally higher.
- Site-specific requirements, such as transportation, labor, interconnection, and permitting, also have an impact.

As presented in Table 1-1 and Table 1-2, two rating systems are used to define an overall confidence level for data presented in technology screening studies. One system is based on a technology's development status; the other is based on the level of effort expended in the design and cost estimate. The confidence levels of the estimates presented in this report reflect technology development statuses ranging from early demonstration trials to mature development, with a preliminary or simplified level of effort. The rating system indicates the level of effort involved in developing the design and cost estimate.<sup>5</sup>

**Table 1-1  
Confidence Rating Based on Technology Development Status**

Letter Rating	Key Word	Description
A	Mature	Significant commercial experience (several operating commercial units)
B	Commercial	Nascent commercial experience
C	Demonstration	Concept verified by integrated demonstration unit
D	Pilot	Concept verified by small pilot facility
E	Laboratory	Concept verified by laboratory studies and initial hardware development
F	Idea	No system, component or device test available

**Table 1-2  
Confidence Rating Based on Cost and Design Estimate**

Letter Rating	Key Word	Description
A	Actual	Data on detailed process and mechanical designs or historical data from existing units
B	Detailed	Detailed process design (Class III design and cost estimate)
C	Preliminary	Preliminary process design (Class II design and cost estimate)
D	Simplified	Simplified process design (Class I design and cost estimate)
E	Goal	Technical design/cost goal for value developed from literature data

---

<sup>5</sup> The focus of this report is primarily mature, commercial and demonstration-ready systems that can be deployed within the next 1 to 3 years.

## **Uncertainties and Accuracy**

Some degree of uncertainty is generally expected in capital cost and performance and operation and maintenance data. Because many storage technologies do not have a long history of construction or operating costs, only estimates can be used. The accuracy of such estimates depends on the quality of technical data and the level of effort involved in the engineering design. Extrapolating cost and performance data on commercially proven technologies to develop estimates of future performance also incorporates a degree of uncertainty due to the influence of factors discussed in this section. Quantifying uncertainty in estimates can aid in understanding and making judgments about a technology's viability.

### ***Sources of Uncertainty***

There are several technical, economic and O&M factors that influence the variations in life-cycle cost from one technology to another and from one application to another. Higher uncertainty regarding the performance of a key component in a new technology will result in more significant impact on the cost estimate. Many factors contribute to the overall uncertainty of an estimate. They can generally be divided into four generic types:

- *Technical*—Uncertainty in physical phenomena, small sample statistics, or scaling.
- *Estimation*—Uncertainty resulting from estimates based on less-than-complete designs
- *Economic*—Uncertainty due to unanticipated changes in the cost of available materials, labor, or capital.
- *Other*—Uncertainties in permitting, licensing and other regulatory actions, labor disruption, weather conditions, or other factors.

As a technology moves along the continuum of development from R&D through commercial installation, the type of risk—and the corresponding uncertainty—tends to change. At the R&D level, technologies face a high degree of both technical and estimation uncertainty. The bandwidth of the uncertainty depends on the number of new and novel parts in a technology and the degree of scale-up required to attain commercial size. The status of a technology, based on the maturity of its components, is critical in meeting the cost and performance estimates scaling up from pilot to demonstration to commercial.

Demonstration and commercialization reduce technical and estimation uncertainties, but economic and other uncertainties always remain. The level of these uncertainties depends largely on the magnitude of capital investment, length of time for field construction, and number of regulatory agencies potentially involved in the project.

## Accuracy

Because of the impact of local site-specific conditions, energy storage system estimates in this report necessarily fall into the simplified or preliminary classifications. When compared with finalized or detailed cost estimate values, these may vary by 10% to 30%. However, since a consistent methodology is used for developing installed capital cost and \$/kW-h delivered estimates, these costs are useful in performing screening assessments for comparing various alternative electric energy storage technologies by application.

Estimates of the range of accuracy for the cost data presented in this section are shown in Table 1-3, which is based on the confidence ratings described previously.

**Table 1-3**  
**Accuracy Range Estimates for Technology Screening Data<sup>1</sup> (Ranges in Percent)**

		% Accuracy in Technology Development Rating				
	Estimate Rating	A Mature	B Commercial	C Demo	D Pilot	E & F Lab & Idea
A	Actual	0	–	–	–	–
B	Detailed	-5 to +8	-10 to +15	-15 to +25	–	–
C	Preliminary	-10 to +15	-15 to +20	-20 to +25	-25 to +40	-30 to +60
D	Simplified	-15 to +20	-20 to +30	-25 to +40	-30 to +50	-30 to +200
E	Goal	–	-30 to +80	-30 to +80	-30 to +100	-30 to +200

<sup>1</sup> This table indicates the overall accuracy for cost estimates. The accuracy is a function of the level of cost-estimating effort and the degree of technical development of the technology. The same ranges apply to O&M costs.

Accuracy ranges can be useful in indicating the overall degree of confidence in a given estimate. Applying accuracy ranges to comparisons of two storage system alternatives may show overlapping costs. However, both alternatives may have many factors in common—for example, construction labor rates, materials, and components. Increases in these factors would cause both alternatives to cost more, and their cost differential would not change significantly.

If a comparison of alternatives incorporating the accuracy ranges produces no overlap, this finding would probably not be reversed in a formal uncertainty analysis. However, accuracy ranges do not by themselves supply sufficient data to compare technologies in an uncertainty analysis.

Current uncertainties in cost escalation, due to high demand for bulk materials such as piping, structural steel, and concrete, has broadened the accuracy ranges in Table 1-3. For a mature technology with a detailed estimate, the accuracy range is about -5 % to +8 %.

In the EPRI's energy storage analysis, accuracy ranges are not directly applied to overall cost estimates to yield an upper and lower bound. Capital cost estimates for various technologies summarized in this report are based on technical data provided as part of the EPRI Energy Storage Program's research, and represent "averaged values" from various sources of supply. The EPRI program also uses process and project contingency to assess uncertainty, and uses this approach to so that differing levels of maturity for storage systems can be treated quantitatively.

The capital costs shown for the technologies in this paper are based on a generic site and labor conditions. Energy storage system cost estimates are in December 2010 dollars.





# 2

## ENERGY STORAGE APPLICATION REQUIREMENTS AND BENEFITS

### Electric Energy Storage Applications

Energy storage systems can provide a variety of application solutions along the entire value chain of the electrical system, from generation support to transmission and distribution support to end-customer uses. The 10 key applications that form the basis of EPRI’s analysis are summarized in Table 2-1. This list is *not* comprehensive.

**Table 2-1  
Definition of Energy Storage Applications**

Value Chain	Application	Description	
Generation & System-Level Applications	1	Wholesale Energy Services	Utility-scale storage systems for bidding into energy, capacity and ancillary services markets <sup>6</sup>
	2	Renewables Integration	Utility-scale storage providing renewables time shifting, load and ancillary services for grid integration
	3	Stationary Storage for T&D Support	Systems for T&D system support, improving T&D system utilization factor, and T&D capital deferral
T&D System Applications	4	Transportable Storage for T&D Support	Transportable storage systems for T&D system support and T&D deferral at multiple sites as needed
	5	Distributed Energy Storage Systems	Centrally managed modular systems providing increased customer reliability, grid T&D support and potentially ancillary services
	6	ESCO Aggregated Systems	Residential-customer-sited storage aggregated and centrally managed to provide distribution system benefits
	7	C&I Power Quality and Reliability	Systems to provide power quality and reliability to commercial and industrial customers
End-User Applications	8	C&I Energy Management	Systems to reduce TOU energy charges and demand charges for C&I customers
	9	Home Energy Management	Systems to shift retail load to reduce TOU energy and demand charges
	10	Home Backup	Systems for backup power for home offices with high reliability value
T&D = Transmission and Distribution; C&I = Commercial and Industrial; ESCO = Energy Services Company; TOU = Time of Use			

<sup>6</sup> This analysis modeled a larger unit providing both energy and ancillary services, and did not focus on a unit designed to provide regulation alone.

Additional energy storage applications exist now and others will emerge in the future, and will be the subject of future research. However, these 10 key applications represent the preponderance of energy storage uses and are of most interest to potential energy storage owners and operators.

EPRI further identified the major stakeholder groups for energy storage systems as:

- Utilities
- Customers
- Independent system operators (ISOs)
- Wholesale market participants (including intermittent generators)
- Retail service providers
- Ratepayers
- Federal regulators and policymakers
- State regulators and policymakers.

Table 2-2 summarizes the stakeholder groups who stand to benefit or be most impacted by these 10 energy storage applications.

**Table 2-2  
Impacted Stakeholders by Application**

Applications		Stakeholder Groups
1	Wholesale Energy Services	Federal regulators, ISOs, state regulators, utilities, wholesale market participants, ratepayers
2	Renewables Integration	Federal regulators, ISOs, state regulators, utilities, wholesale market participants, ratepayers
3	Stationary T&D Support	Federal regulators, ISOs, state regulators, utilities, wholesale market participants, ratepayers
4	Transportable Storage for T&D Support	Federal regulators, ISOs, state regulators, utilities, wholesale market participants, ratepayers
5	Distributed Energy Storage Systems	State regulators, utilities, retail service providers, customers, ratepayers
6	ESCO Aggregated Systems	State regulators, utilities, retail service providers, customers, ratepayers
7	C&I Power Quality and Reliability	State regulators, utilities, retail service providers, customers, ratepayers
8	C&I Energy Management	State regulators, utilities, retail service providers, customers, ratepayers
9	Home Energy Management	State regulators, utilities, retail service providers, customers, ratepayers
10	Home Backup	State regulators, utilities, retail service providers, customers, ratepayers

For this analysis, the present value (PV) of benefits for each application is compared against the total costs of installing an energy storage system. These estimates are analogous to the Total Resource Cost-effectiveness Test (TRC), which compares costs and benefits for a region as a whole regardless of who actually pays the cost or receives the benefits. For applications focused on utility and ISO system benefits, the TRC costs and benefits are equivalent to those from the Utility Cost Test perspective (UCT, also known as the Program Administrator Cost Test, or PAC). They can therefore be used to compare energy storage to alternative investments considered in the utility integrated resource planning process. No environmental, societal or non-energy benefits are included in the benefits presented here. For behind-the-meter applications, the benefits reflect the customer “Participant Cost Test” (PCT) perspective showing what storage is worth to the customer. This perspective includes bill savings that are a benefit to the customer, but which represent a loss of revenue to utilities and are higher than the wholesale value of the energy and capacity benefits to the region. The allocation of benefits and costs to individual user groups or stakeholders is not considered. Consequently, this approach looks at the cumulative benefits of the applications but not at the specific business cases and ownership models that should be addressed in advance of any capital investment in energy storage.

Each of the 10 applications defined for this analysis centers around a specific operational goal but provides multiple benefits. Each benefit represents a discrete use of energy storage that can be quantified and valued. Due to the current high installed capital costs of most energy storage systems, applications (for either utilities or end users) must be able to realize multiple operational uses across different parts of the energy value chain, an aggregation of complementary benefits known as “stacking.” This concept is illustrated in Figure 2-1 for many of the energy storage functions served by the key applications.

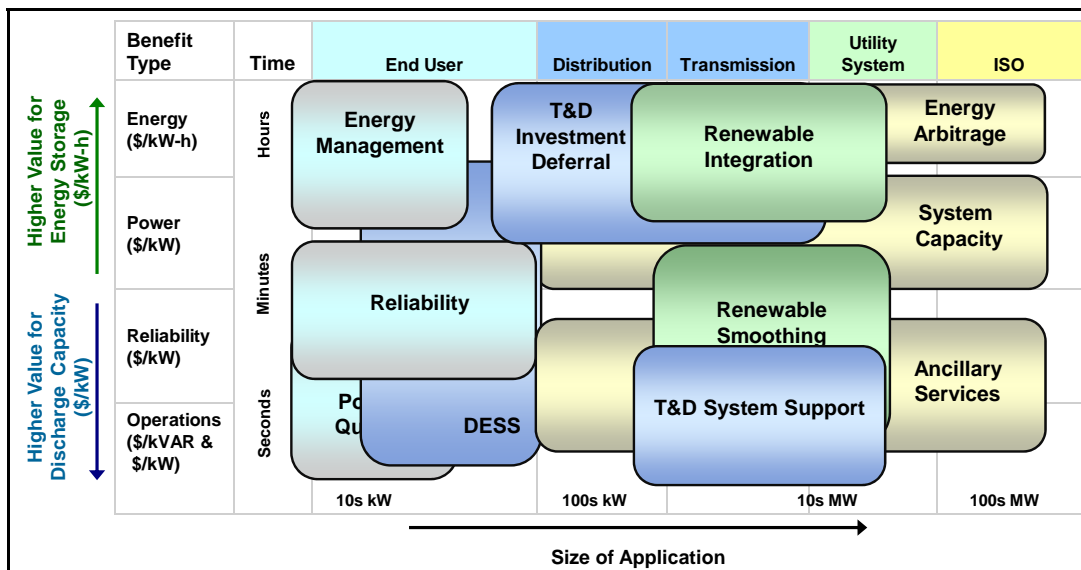
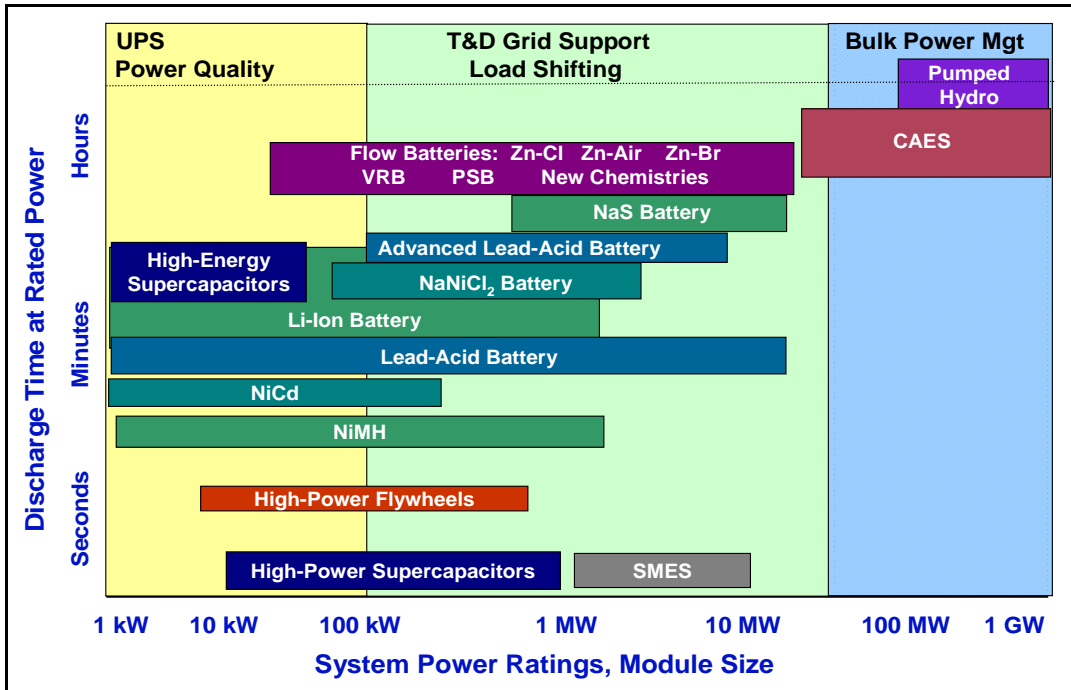

Figure 2-1  
Operational Benefits Monetizing the Value of Energy Storage

For purposes of comparison, Figure 2-2 illustrates the characteristics of various energy storage technology options in terms of system power rating along the X-axis and duration of discharge time at rated power on the Y-axis. For both figures, these comparisons are very broad, intended for conceptual purposes only; there are many examples of individual applications and energy storage systems that do not fall within the ranges shown. Application requirements and technology characteristics are discussed further below.



**Figure 2-2**  
Positioning of Energy Storage Technologies<sup>7</sup>

As emphasized previously, energy storage economics is highly dependent on the technology costs and potential revenues for both the discharge capacity (MW) and energy storage capacity (MWh). In covering a broad array of technologies, benefits, and applications, the relative importance of discharge capacity and energy delivery was considered in defining the size configuration and technologies modeled for each storage application. However, a detailed optimization incorporating technology costs, operational characteristics, and potential revenues to determine the best configuration for each technology and application was beyond the scope of this study. Furthermore, our modeling does not account for the difference in power delivery capability (inertia or momentum), response rates, or maximum ramp rates of storage systems, which will be important criteria for certain benefits such as ancillary services and renewables integration.

<sup>7</sup> The general technology characteristics and ranges of performance indicated in this figure are illustrative, not definitive. Specific examples that fall outside the ranges indicated can be found for many of these energy storage technologies. For example, Li-ion discharge times can range as high as 2 to 4 hours.

## Energy Storage Application Requirements and Value of Benefits

For this study, 10 applications for energy storage were defined, each of which has the potential to group multiple benefits. Table 2-3 provides an overview of the technical and energy storage performance requirements for each application.

**Table 2-3**  
**General Energy Storage Application Requirements <sup>1</sup>**

Application	Description	Size	Duration	Cycles	Desired Lifetime
Wholesale Energy Services	Arbitrage	10-300 MW	2-10 hr	300-400/yr	15-20 yr
	Ancillary services <sup>2</sup>	See note 2	See Note 2	See Note 2	See Note 2
	Frequency regulation	1-100 MW	15 min	>8000/yr	15 yr
	Spinning reserve	10-100 MW	1-5 hr		20 yr
Renewables Integration	Wind integration: ramp & voltage support	1-10 MW distributed 100-400 MW centralized	15 min	5000/yr 10,000 full energy cycles	20 yr
	Wind integration: off-peak storage	100-400 MW	5-10 hr	300-500/yr	20 yr
	Photovoltaic Integration: time shift, voltage sag, rapid demand support	1-2 MW	15 min-4 hr	>4000	15 yr
Stationary T&D Support	Urban and rural T&D deferral. Also ISO congestion mgt.	10-100 MW	2-6 hr	300-500/yr	15-20 yr
Transportable T&D Support	Urban and rural T&D deferral. Also ISO congestion mgt.	1-10 MW	2-6 hr	300-500/yr	15-20 yr
Distributed Energy Storage Systems (DESS)	Utility-sponsored; on utility side of meter, feeder line, substation. 75-85% ac-ac efficient.	25-200 kW 1-phase 25-75 kW 3-phase Small footprint	2-4 hr	100-150/yr	10-15 yr
C&I Power Quality	Provide solutions to avoid voltage sags and momentary outages.	50-500 kW	<15 min	<50/yr	10 yr
		1000 kW	>15 min		
C&I Power Reliability	Provide UPS bridge to backup power, outage ride-through.	50-1000 kW	4-10 hr	<50/yr	10 yr
C&I Energy Management	Reduce energy costs, increase reliability. Size varies by market segment.	50-1000 kW Small footprint	3-4 hr	400-1500/yr	15 yr
		1 MW	4-6 hr		
Home Energy Management	Efficiency, cost-savings	2-5 kW Small footprint	2-4 hr	150-400/yr	10-15 yr
Home Backup	Reliability	2-5 kW Small footprint	2-4 hr	150-400/yr	10-15 yr

1. Size, duration, and cycle assumptions are based on EPRI's generalized performance specifications and requirements for each application, and are for the purposes of broad comparison only. Data may vary greatly based on specific situations, applications, site selection, business environment, etc.

2. Ancillary services encompass many market functions, such as black start capability and ramping services, that have a wide range of characteristics and requirements.

These data are based on EPRI's generalized performance specifications and requirements, and are for the purposes of broad comparison only. System characteristics may vary greatly based on specific applications, site selection, and business environment. In the near future, EPRI's Energy Storage R&D Program will develop more detailed application requirements for market applications of interest to the utility sector.

EPRI's research identified and modeled 21 benefits of energy storage (Table 2-4). Other benefits or additional uses exist but are not modeled or quantified here. These benefits include ramping, greenhouse gas reductions through improved renewable operations, arbitrage between less CO<sub>2</sub>-efficient and more CO<sub>2</sub>-efficient generation sources, and avoidance of cycling, wear and tear, and ramping of fossil power plants to support wind generation.<sup>8</sup>

A variety of data sources and prior studies were used to develop estimates for benefit values (See Appendix A). To provide a sense of their potential relative values, value estimates for storage systems are presented as "target" and "high" estimates. Target values represent an average value in the broader U.S. market for stakeholders who might consider investing in energy storage, while high values represent the value for premium or niche markets that place a particularly high value on the benefits provided by an energy storage system. As an example, for Power Reliability the *target* value is based on an average outage cost survey, whereas for the *high* value the 95th percentile is used.

This table shows the value of each individual benefit quantified in this analysis for purposes of a relative comparison only. Site-specific values may vary substantially from the figures presented here. The values for distribution deferral, transmission deferral, transmission congestion and price arbitrage are particularly variable and location specific. In addition, *the values presented are not additive*. The benefits must be modeled together in an integrated fashion, since providing some benefits in a particular hour will necessarily preclude others.

---

<sup>8</sup> Quantifying such benefits would require production simulation modeling of the regional transmission grid and generation portfolio, which is beyond the scope of this study.

**Table 2-4**  
**Representative Benefit PVs of Selected Energy Storage Benefits (expressed as \$/kW-h and \$/kW)**

Value Chain	Benefit		PV \$/kW-h		PV \$/kW	
			Target	High	Target	High
End User	1	Power Quality	19	96	571	2,854
	2	Power Reliability	47	234	537	2,686
	3	Retail TOU Energy Charges	377	1,887	543	2,714
	4	Retail Demand Charges	142	708	459	2,297
Distribution	5	Voltage Support	9	45	24	119
	6	Defer Distribution Investment	157	783	298	1,491
	7	Distribution Losses	3	15	5	23
Transmission	8	VAR Support	4	22	17	83
	9	Transmission Congestion	38	191	368	1,838
	10	Transmission Access Charges	134	670	229	1,145
	11	Defer Transmission Investment	414	2,068	1,074	5,372
System	12	Local Capacity	350	1,750	670	3,350
	13	System Capacity	44	220	121	605
	14	Renewable Energy Integration	104	520	311	1,555
ISO Markets	15	Fast Regulation (1 hr)	1,152	1,705	1,152	1,705
	16	Regulation (1 hr)	514	761	514	761
	17	Regulation (15 min)	4,084	6,845	1,021	1,711
	18	Spinning Reserves	80	400	110	550
	19	Non-Spinning Reserves	6	30	16	80
	20	Black Start	28	140	54	270
	21	Price Arbitrage	67	335	100	500

Note: each benefit is modeled in isolation using a consistent battery configuration of 1 MW of discharge capacity and 2 MWh of energy storage capacity, with a 15-year life and a 10% discount rate.

## Energy Storage Application Values

In this analysis, the operation of each technology/application combination was simulated over the course of one year in a sequential hourly dispatch model. The technical specifications of the technology constrained the operations of the modeled storage device,

accounting for charging and discharging capacity (in kW), energy storage capacity (in kW-h), round-trip efficiency and minimum depth of discharge, among other factors. Within those constraints, each energy storage device was dispatched based on expected prices to maximize revenue over the course of a day. Although other methods were explored, perfect foresight was used to provide the most consistent comparison of value across benefits and markets. For each application selected, ratios of discharge capacity to energy storage capacity were modeled.

End-user reliability applications require maintaining the battery at or near full capacity throughout the year because customer outages can occur at any time. For other applications, revenue was maximized with a two-mode operation. During a selected number of peak hours, the modeled energy storage system was kept full to provide local or system capacity and local voltage support (Capacity Mode). However, maintaining full capacity prevents the battery from participating in ancillary service and energy markets. For the remaining hours, the battery is free to cycle up and down to provide a greater range of benefits, including time shifting, energy arbitrage and ancillary services (Dispatch Mode).

The energy storage applications that achieve the highest revenues do so by aggregating several benefits across multiple categories. This combination of benefits is illustrated by the application of Stationary T&D Support shown in Figure 2-3 and Figure 2-4.

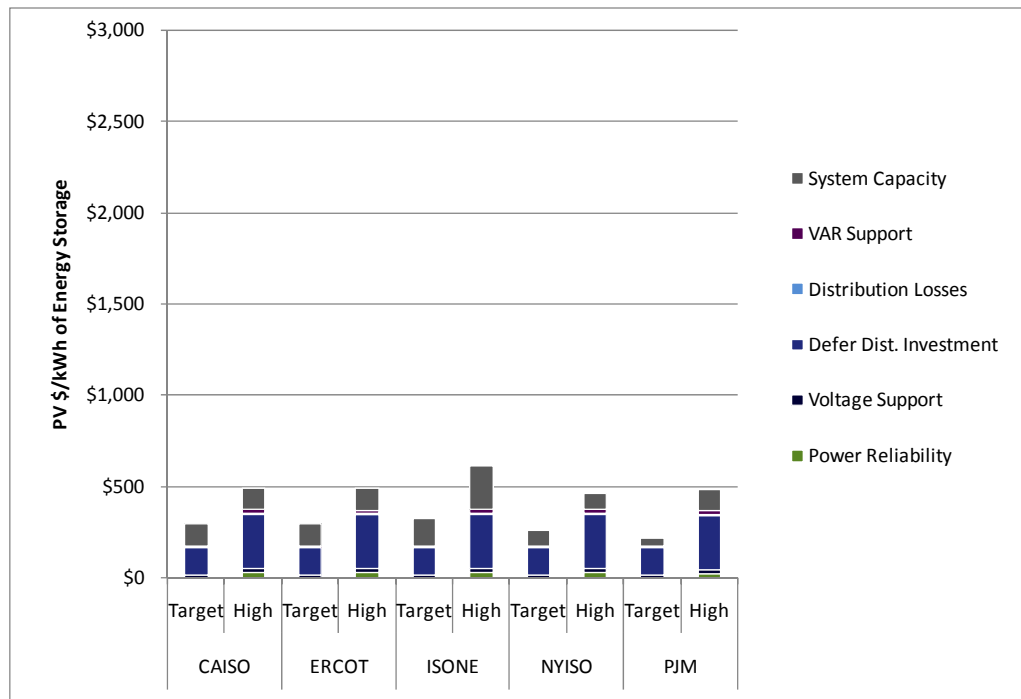

**Figure 2-3**  
**Stationary T&D Deferral—No Ancillary Services**



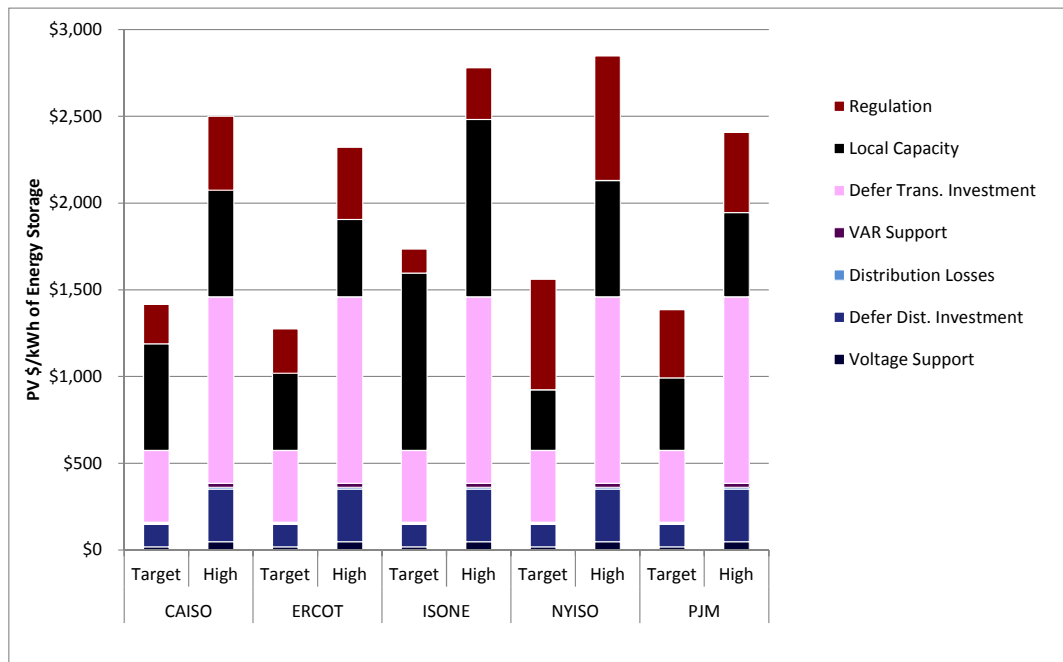

**Figure 2-4**  
**Stationary T&D Deferral, with Regulation and Transmission Deferral**

Under one scenario, the storage system provides end-user reliability benefits, distribution system support benefits, and system capacity. However, even with the aggregation of benefits across these three categories, the PV of benefits is estimated to be under \$500/kWh of energy storage for both the target (average) and high values for the ISO markets modeled.

In another scenario, for the same application, the energy storage system is able to provide regulation services, is located in an area with local capacity requirements, and is able to potentially defer transmission investments. In this case, the PV of benefits ranges from \$1,228–\$1,816 per kWh of energy storage for the target values and \$2,211–\$2,755/kWh for the high values shown in Figure 2-4. However, the locations at which all of these benefits can be realized together are limited, as explained in the market size discussion below.

For most applications, the values are presented represent both the regional (TRC) and utility/ISO (PAC) perspectives, and can be directly compared to alternative utility investments. The end-use energy management applications reflect the customer or participant (PCT) perspective and are a measure of how much a retail customer would be willing to pay for energy storage. Because the customer bill savings are generally higher than the wholesale value of the energy and capacity, the customer perspective is higher than the actual value to the region or utility. For those benefits that involve bidding into competitive markets, historical price data was used from 2006-2008 for five ISOs: CAISO,

ERCOT, ISONE, NYISO and PJM. For presentation in this summary, a single year and ISO were selected for each benefit value to best represent a target or high value.<sup>9</sup>

Figure 2-5 provides estimates for the total value for each of the 10 key energy storage applications examined. Applications that include end-user benefits were further broken out by customer class, for a total of 16 distinct application values. In contrast to Table 2-4, which shows individual benefit values, this figure shows the present value (PV) for the applications, which group multiple benefits together. For each application, the operational characteristics of a selected, appropriate technology were used. As before, all values are presented from the regional (TRC) perspective except for the end-use energy management applications (*those applications in the figure with an asterisk*), which reflect the customer PCT perspective and include bill savings that represent a loss of revenue to utilities.

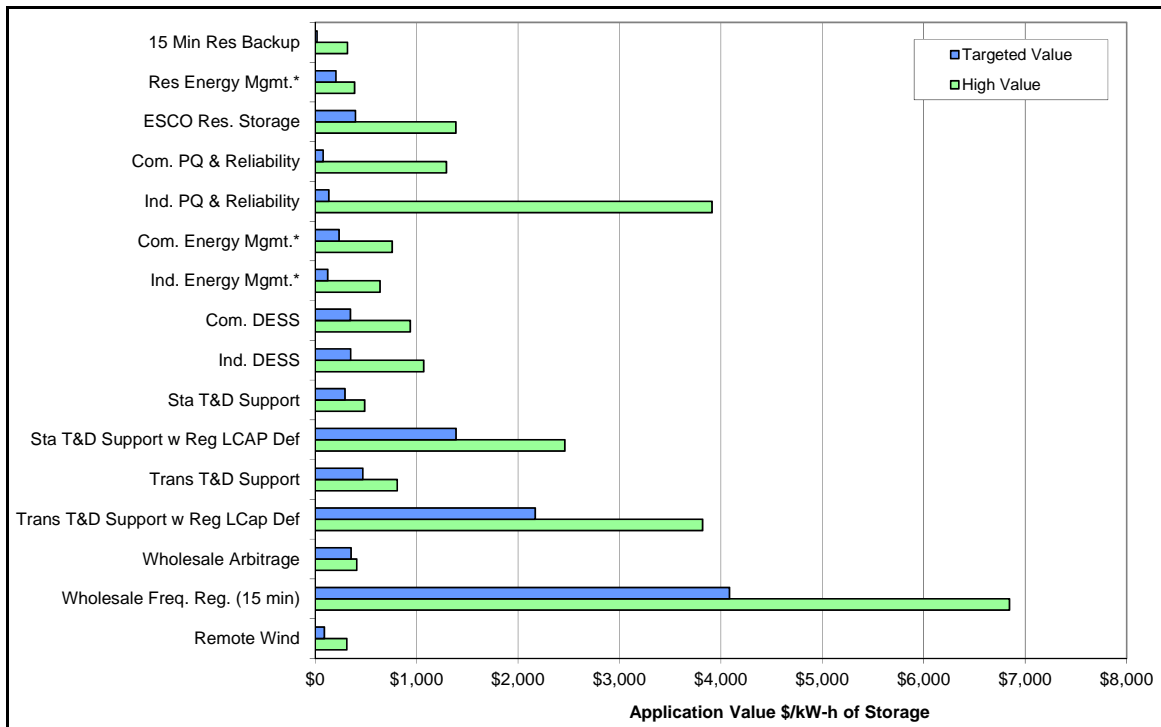

**Figure 2-5**  
**Summary of Target and High Application Present Values for Energy Storage in \$/kW-h**

For each energy storage application, the value of storage was estimated over the expected useful life of the storage system. The present value of revenue for each application was estimated using a 10% discount rate to approximate the perspective of a regulated utility considering an investment in energy storage. That PV was then divided by the discharge

<sup>9</sup> The year and ISO differed for each competitive market, but in general a figure close to the average across all years and ISOs was chosen for the target value, and a figure at the upper end of the range was chosen for the high value.

capacity (kW) and energy storage capacity (kW-h) to calculate a \$/kW and \$/kW-h<sup>10</sup> value for energy storage.

For comparison purposes, Figure 2-5 shows the value of energy storage in PV \$/kW-h. For this comparison, the battery or energy storage system is not consistent across all applications; instead, an appropriate technology and size was selected for each application. The modeling of each application is further described in Appendix A. The critical battery characteristic affecting an application's PV is useful lifetime (in years). The round-trip efficiency and minimum depth of discharge had a relatively minor effect over the range of technologies modeled for each application.

PV revenues sum up revenues across different categories of benefits, regardless of whether a customer, utility, ISO or independent third-party entity receives the benefits. As previously discussed, these estimates are therefore analogous to the Total Resource Cost-effectiveness Test (TRC), which compares costs and benefits for a region as a whole regardless of who actually pays the cost or receives the benefits. The TRC perspective is often used by utilities to justify investments in energy efficiency or other programs. For all but the customer behind-the-meter applications, the benefits included in the TRC are also those that would be seen by a utility (no societal or environmental adders are included). Therefore, the benefits also represent the value of the storage device to a utility or ISO (UCT/PAC). Under one scenario, the storage system provides end-user reliability benefits, distribution system support benefits, and system capacity. However, even with the aggregation of benefits across these three categories, the PV of benefits is estimated to be under \$500/kW-h of energy storage for both the target (average) and high values for the ISO markets modeled. Applications with the highest PV of benefits from the regional or utility perspective are:

- Commercial and Industrial Power Quality and Reliability,
- Stationary Storage for T&D Support,
- Transportable Storage for T&D Support, and
- Wholesale Services with Regulation (15 minute).

From the customer perspective, retail energy bill savings also provide potentially significant benefits for:

- Home Energy Management, and
- Commercial and Industrial Energy Management.

However, since such end-user savings represent a loss of revenue to the utility, their benefits from the regional (TRC) perspective would be lower.

---

<sup>10</sup> \$/kW-h is the \$/kW divided by the hours duration of the storage system. The term "\$/kW-h of storage" should not be confused with the cost of electricity, often described as \$/kWh, or the levelized cost per kWh discussed elsewhere in this report.

As noted, energy storage applications that achieve the highest estimated revenues do so by aggregating several benefits across multiple categories. The analysis indicates that capturing multiple benefits—including transmission and distribution (T&D) deferral and ancillary services—will be critical for high-value applications. Appendix A of this report provides a more detailed outline of the methodology and underlying key assumptions and inputs employed to reach those conclusions.

## **Comparison to Alternative Energy Storage Benefit Valuations**

Many other researchers and organizations are attempting to determine the market potential for energy storage. Within the energy storage literature, storage application naming conventions and assumptions vary, which may make a brief comparison between those studies and this white paper useful.

One prominent source for information on the benefits of energy storage is a report published by the DOE Sandia National Laboratories (SNL) Energy Storage Systems (ESS) program titled *Energy Storage for the Electricity Grid: Benefits and Market Potential Assessment Guide* ( SAND2010-0815), published in February 2010. A brief characterization of the scope and goals of the SNL report provides important context for this white paper because the guide is a widely distributed and cited reference that addresses many of the same themes addressed herein.

The SNL assessment guide was an update of a previous report published in December 2004: *Energy Storage Benefits and Market Analysis Handbook* (SAND2004-6177). That report was produced as a reference for proposers of storage demonstration projects sponsored by the California Energy Commission and DOE/SNL, and both focused on California rather than nationwide, as this white paper does. Both SNL reports had two goals: to provide an introduction to, and a high-level appreciation of, the rich menu of current and future benefits storage could provide without regard to cost; and to offer a starting point for estimating the financial value of energy storage benefits. The scope of both SNL reports includes:

- Qualitative characterizations of specific direct and incidental benefits associated with storage use;
- General guidance about estimating (quantifying) the financial value of most of those benefits, including a general methodology and caveats; and
- General guidance and caveats regarding aggregation of individual benefits into value propositions.

In general, the SNL report takes a top-down approach to valuation, whereas analysis in this white paper takes a bottom-up approach. In many cases, the SNL report uses California values to extrapolate to nationwide results. The SNL report also defines which benefit values could be targeted simultaneously by a given storage device, but does not value such

a devices' optimal dispatch. The approach taken in this white paper provides more detail at the regional (ISO) level, and also attempts to value battery applications—that is, battery uses involving multiple benefit values which are defined by specific applications.

The SNL and EPRI approaches also employ different assumptions to calculate present value. The SNL report assumes generic financials: 10 years of storage life for all benefits including 2.5% general inflation and a 10% discount rate. The analysis in this report applies multiple storage life assumptions based on estimates for each technology. This white paper also uses a 10% discount rate but does not escalate benefit values.

It is somewhat difficult to compare the values of the SNL and EPRI reports because they employ different metrics. For storage with a specific discharge duration, the SNL report compares all benefit values on a \$/kW basis, which is a familiar metric for utilities. However, the approach described in this white paper is designed to perform a technology cost-benefit analysis. A battery with a capacity of 1 MW and duration of 2 hours will cost less than a battery with a capacity of 1 MW and duration of 6 hours. For this reason, this white paper presents all values on a \$/kW-h basis.

Table 2-5 compares benefit values from the SNL report with the equivalent EPRI white paper values. All figures are shown on a present value \$/kW-h and \$/kW basis. The SNL values are converted from \$/kW to \$/kW-h by dividing by the greater of SNL's defined battery duration capacity or 1 hour. For example, Transmission Support is listed with duration of 2 to 5 seconds in the report, but in practice a battery would be sized with duration of much greater than 5 seconds, so 1 hour is assumed for the purposes of this comparison. For additional detail, the EPRI benefits were converted from \$/kW-h to \$/kW using the same battery durations assumed in the SNL report. Note that these duration assumptions are not always the same as those made throughout the white paper, but are offered here for the sake of comparison.

Given the caveats in comparing benefit values from the EPRI and SNL reports, Table 2-5 provides insight into the relative values of each application as presented in the reports. Two applications stand out as having the largest difference in value within the two reports: Area Regulation and T&D Upgrade Deferral. In the case of regulation, the SNL report presents higher values, whereas for T&D Upgrade Deferral, the EPRI report presents higher values.

The SNL approach to valuing the benefit of 1 hour of regulation combines the CAISO regulation market prices for regulation-up and regulation-down from 2006, and takes the average combined value. The SNL report then assumes a capacity factor of storage operation to perform a life-cycle cost analysis. This approach assumes an energy neutral regulation dispatch. In addition, the SNL report values do not include a battery round-trip efficiency penalty although the report does explain how that penalty would be calculated. The EPRI valuation of regulation uses an hourly dispatch simulation to model the values that the energy storage device could accrue and uses regulation market prices from CAISO, ERCOT, PJM, NYISO and ISO-NE from 2006, 2007, 2008. The EPRI report assumes an

energy biased regulation signal which leads to periodic storage charging that is treated as a cost to the system.

The EPRI report gives T&D Upgrade Deferral a higher value than does the SNL report. The valuation methodologies of the two reports is similar, but the main difference is that the EPRI report assumes T&D Upgrades can be deferred for multiple years, whereas the SNL report looks at the value of a single year of deferral. The SNL report notes that power engineers must reassess whether storage can be used for deferral (SNL 86). This valuation rationale is valid, but the EPRI report assumes that there could be a transportable R&D system that could be moved to defer multiple T&D projects over the battery lifetime. However, successful utilization of a transportable storage device in multiyear T&D planning is uncertain.

**Table 2-5  
Representative Benefit PVs of Selected Energy Storage Benefits**

SNL Report		EPRI White Paper		PV \$/kW-h				PV \$/kW			
				SNL Benefits		EPRI Benefits		SNL Benefit		EPRI Benefits	
Application	Duration	Application	Duration	Low	High	Target	High	Low	High	Target	High
Electric Energy Time-shift	2-8 hrs	Price Arbitrage	2-8 hrs	\$50	\$350	\$67	\$100	\$400	\$700	\$134	\$800
Electric Supply Capacity	5-6 hrs	System Capacity	5-6 hrs	\$60	\$142	\$44	\$121	\$359	\$710	\$220	\$726
Area Regulation	1 hr	Regulation (1 hr)	1 hr	\$785	\$2,010	\$255	\$426	\$785	\$2,010	\$255	\$426
Electric Supply Reserve Capacity	1-2 hrs	Spinning Reserves	1-2 hrs	\$29	\$225	\$80	\$110	\$57	\$225	\$80	\$220
Voltage Support	1 hr	Voltage Support	1 hr	\$400	\$400	\$9	\$24	\$400	\$400	\$9	\$24
Transmission Support	1 hr	VAR Support	1 hr	\$192	\$192	\$4	\$17	\$192	\$192	\$4	\$17
Transmission Congestion Relief	3-6 hrs	Transmission Congestion	3-6 hrs	\$5	\$47	\$38	\$368	\$31	\$141	\$114	\$2,208
T&D Upgrade Deferral 50th Percentile	3-6 hrs	Defer Transmission Investment	3-6 hrs	\$80	\$229	\$414	\$1,074	\$481	\$687	\$1,242	\$6,444
T&D Upgrade Deferral 90th Percentile	3-6 hrs	Defer Transmission Investment	3-6 hrs	\$127	\$360	\$414	\$1,074	\$759	\$1,079	\$1,242	\$6,444
Time-of-use Energy Cost Management	4-6 hrs	Retail TOU Energy Charges	4-6 hrs	\$204	\$307	\$377	\$543	\$1,226	\$1,226	\$1,508	\$3,258
Demand Charge Management	5-11 hrs	Retail Demand Charges	5-11 hrs	\$53	\$116	\$142	\$459	\$582	\$582	\$710	\$5,049
Electric Service Reliability	1 hr	Power Reliability	1 hr	\$359	\$978	\$47	\$537	\$359	\$978	\$47	\$537
Electric Service Power Quality	1 hr	Power Quality	1 hr	\$359	\$978	\$19	\$571	\$359	\$978	\$19	\$571
Renewables Energy Time-Shift	3-5 hrs	Price Arbitrage	3-5 hrs	\$47	\$130	\$67	\$100	\$233	\$389	\$201	\$500
Renewables Capacity Firming	2-4 hrs	System Capacity	2-4 hrs	\$177	\$458	\$44	\$121	\$709	\$915	\$88	\$484
Wind Generation Grid Integration, Short Duration	1 hr	Renewable Energy Integration	1 hr	\$500	\$1,000	\$104	\$311	\$500	\$1,000	\$104	\$311
Wind Generation Grid Integration, Long Duration	1-6 hrs	Renewable Energy Integration	1-6 hrs	\$17	\$782	\$104	\$311	\$100	\$782	\$104	\$1,866

Note: SNL included three benefit values, Load Following, Substation On-site Power, and Transmission Support which were not modeled using a similar methodology in the EPRI White Paper.





# 3

## MARKET SIZE & POTENTIAL

---

### Approach to Market Analysis

EPRI research in 2009 estimated the relative market size for each of the energy storage applications, as summarized in the EPRI report *Energy Storage Market Opportunities: Application Value Analysis and Technology Gap Assessment* (1017813). The market sizing was intended to be a “snapshot” analysis of the current U.S. market size. The study did not estimate future applications or account for expansion or growth in the current applications. In addition, the market sizing study did not take into account the cost-effectiveness of the energy storage application. It was solely an analysis of the current individual market size for each application.

The size estimates do account for some overlap between markets, as each application includes multiple benefits and several applications will compete for the same markets. As a general rule, it is assumed that utility or wholesale applications and the applications with the highest PVs will have some advantages in capturing high-value benefits (for example, regulation services).

The 2009 EPRI report was also intended to be a bottom-up assessment of the market for energy storage in the United States. For example, the report looks at actual energy price data from each ISO in order to get an accurate value for energy price arbitrage nationwide. Other benefit values are also determined on a region by region basis. This is in contrast to many other prominent energy storage reports, which determine market sizes via a top-down approach.

EPRI’s market analysis estimates three market sizes: technical market potential, targeted market potential, and high-value market potential. “Technical potential” estimates the total market size without consideration of feasibility or value. For residential and commercial applications, this is a broad assessment of the end-user load. For T&D deferral applications, it is an assessment of the total deferral market. In wholesale applications, it is the total ancillary service market size.

The “targeted market potential” is the market size that is possible given adoption rates of energy technologies similar to storage. The targeted market size is not equivalent to “economic” potential because a cost-benefit analysis is not included in the market size analysis. Figure 3-1 shows both the Targeted Market Size and Targeted Value for several energy storage applications.

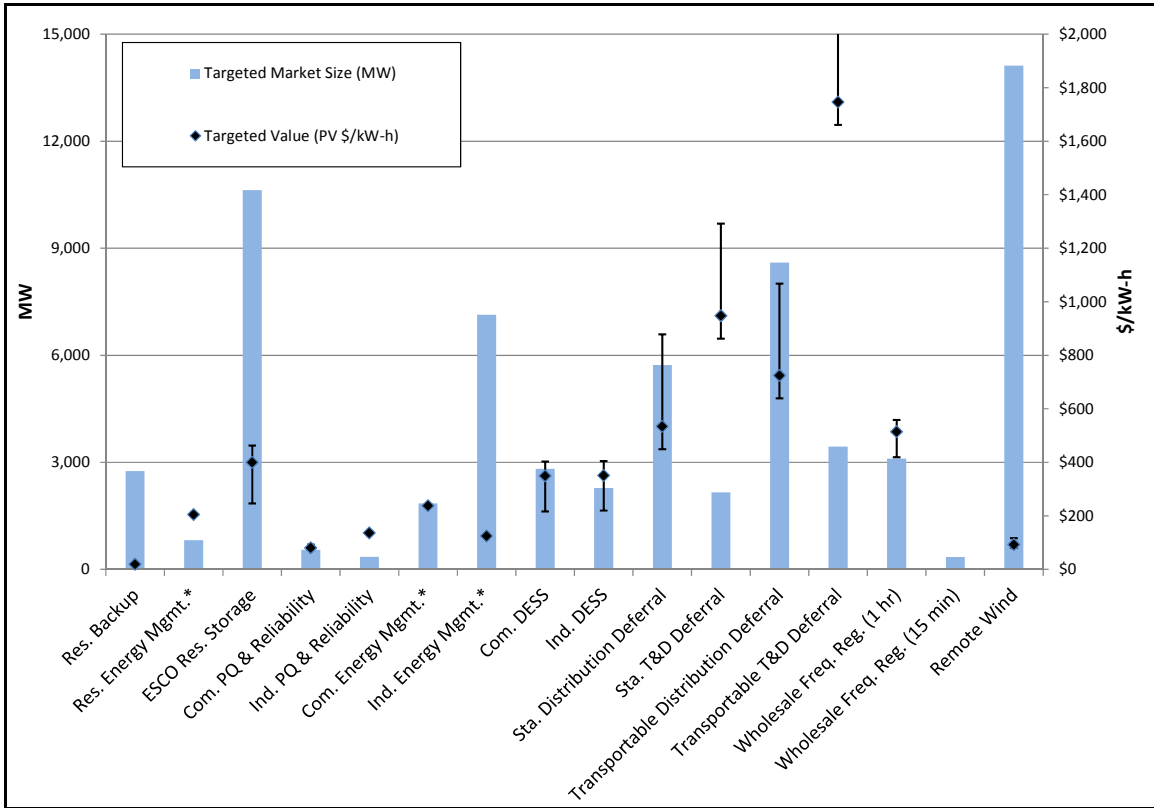

**Figure 3-1**  
**Summary of Target Value Application Market Sizes and Present Value Benefits**  
 (Note that the target value for Wholesale Frequency Regulation (15 min) is \$4,328–\$7,088/kW-h and is not shown on this figure.)

The technical potential was narrowed to the targeted potential using program adoption rates seen in end-user energy efficiency product uptake and third-party demand response program surveys targeting end-user applications. Commercial and residential energy efficient appliances have expected adoption rates between 30% and 40%. Third-party demand response programs have lower rates of uptake.

Although it is difficult to predict how consumers will respond to the relatively new energy storage technologies, the analysis assumes that the mid-range of the energy efficient product adoption rate (35%) is a reasonable proxy for direct customer adoption of energy storage systems. For ESCO or utility-owned systems targeting end users, the analysis assumes adoption rates similar to those seen in demand response programs: 15%, 20% and 25% for residential, commercial and industrial customers, respectively. Utility-sited applications are capable of higher adoption once storage solutions have been shown to be grid-ready, and will depend on the business case. It was assumed there would be an 80% adoption for utility and system applications.

The “high-value market potential” represents niche markets that offer the highest values for energy storage applications (Figure 3-2). The definition of high value varies based on the market for the application. In general, the market size for an application is assumed to be limited by the market size for the highest-valued benefit value. In the case of distribution deferral applications, for example, the market size is limited by the size of the distribution investment deferral benefit value rather than the VAR-support benefit value because distribution investment deferral is the primary value.

The high-value market size definition is typically meant to represent the market size of the top 90th to 95th percentile of benefit values. For example, the high-value distribution deferral market size is based on the megawatts of distribution investments that are at or above the 95th percentile for range-of-deferral values found throughout the United States. There are exceptions to the 90th to 95th percentile range, however. For the high-value market size of the “Wholesale Services with Regulation” application, the high-value market size is equivalent to the markets with the highest regulation prices: NYISO, PJM, and ISONE. These markets make up slightly over 50% of the ISOs studied in this report.

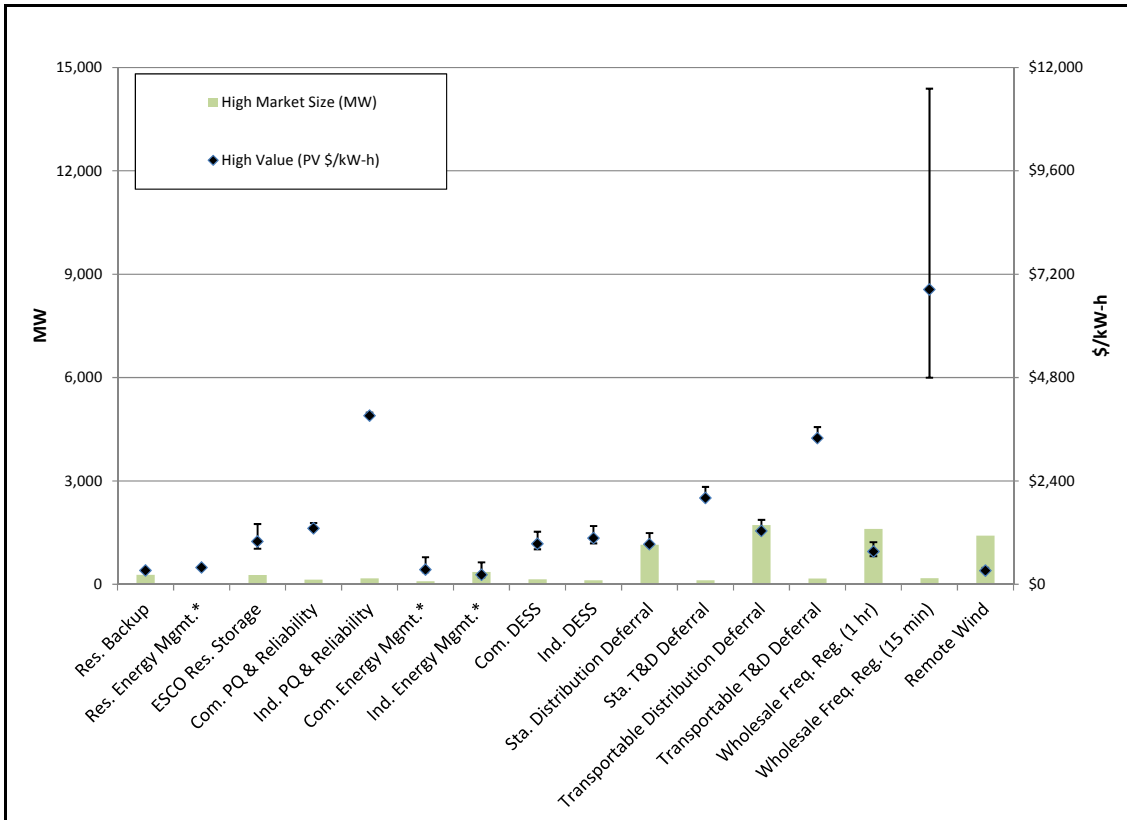

**Figure 3-2**  
**Summary of High-Value Application Market Sizes and Present Value Benefits**

## **Analysis of Markets for Energy Storage Applications**

The following subsections describe the characteristics and estimated market sizes for broad classes of selected energy storage applications: System Integration—which encompasses applications such as Wholesale System Applications, Wind Integration, and Photovoltaic Integration—Utility Applications, Distributed Energy Storage Applications, Commercial and Industrial Applications, and Residential Applications.

### ***System Applications***

System applications are those in which energy storage provides wholesale market opportunities as well as other benefits such as energy arbitrage, reduced transmission congestion, lower local marginal prices, voltage regulation, and frequency regulation to utilities, customers and society.

Such energy storage systems would generally be in the size range of 50 to 400-plus MW with 6 to 10-plus hours for bulk storage, to 1 to 50 MW with 15 minutes to 1 hour of storage for smoothing intermittent renewable generation and balancing supply and demand. Technology options for system applications include pumped hydro, compressed air energy storage (CAES) with underground storage, large flow batteries such as zinc-bromine and vanadium redox, large advanced lead-acid battery systems, lithium-ion batteries, and flywheel systems. Emerging technologies still in the R&D phase such as zinc-air, zinc-chlorine, and other battery chemistries also have potential, but must first be proven and demonstrated at smaller scales.

Many industry experts believe energy storage systems will play a key role in supporting frequency regulation, ancillary services and wind integration, relieving transmission and distribution (T&D) congestion, and improving the balance of supply and demand. However, there are very limited “integrated” regional studies and analyses available that estimate how much, where, and what types of energy storage systems are most effective for wind integration. Uncertainties remain regarding the effectiveness of energy storage in improving wind integration, as well as the capacity and location of storage required in each region under various wind penetration assumptions. A 2009 EPRI report<sup>11</sup> assessed the “system-wide” benefits of energy storage using market-based, integrated analytic tools.

Market simulations in ERCOT indicated a marginal increase in greenhouse gas emissions due to the interaction of storage with coal generation. Simulations of large CAES units showed they can reduce congestion in transmission lines, thereby enabling approximately 100 GWh more wind energy to be delivered annually.

---

<sup>11</sup> *Economic and Greenhouse Gas Emission Assessment of Utilizing Energy Storage Systems in ERCOT*, EPRI, Palo Alto, CA: September 2009 (1017824).

The study also showed the societal and system benefits of small-battery distributed energy storage systems can be very significant when storage systems are targeted at specific load centers where there are high local marginal price (LMP) nodes on the system. Since this simulation was based on the Texas post-CREZ 2 scenario assumptions, in which a large build-out of the transmission system has already taken place, the research findings underestimated the value of energy storage in relieving congestion and reducing LMP. Further studies of this type should be undertaken in regions of the United States with high wind penetration where T&D investments are planned.

### Wind Integration

More wind generation is likely to be deployed over the next 30 years if policies to reduce CO<sub>2</sub> emissions are implemented. EPRI's Prism Analysis estimates a feasible technical potential for new renewable generation by 2030 of about 135 GW, or 15% of the generation mix, of which roughly 100 GW could be composed of new wind generation. EPRI energy-economic analysis indicates that even more wind capacity could be economically viable under very strong CO<sub>2</sub> emissions limits.<sup>12</sup> Many experts believe that some form of electric energy storage will be needed to support electric system balancing and improve the capacity factor of wind generation on the system, which is now less than 40% and could be less than 30% when wind generation must be curtailed due to transmission constraints. Storage can help by inventorying electricity at night when demand is low, and act as a shock absorber by smoothing out wind ramping fluctuations.



**Figure 3-3**  
**Maple Ridge Wind Farm, New York (Source: NREL)**

Just how much energy storage is needed in the United States to meet the needs of wind variability and system balancing, and at which specific locations as a function of wind

---

<sup>12</sup> *The Power to Reduce CO<sub>2</sub> Emissions: The Full Portfolio*, EPRI, Palo Alto, CA.: 2009 (1019563); *Prism/MERGE Analyses: 2009 Update*, EPRI, Palo Alto, CA: 2009 (1020389)

penetration, is not well understood. Further research, including integrated market analysis with T&D investment scenarios, is needed within each of the RTO areas.<sup>13</sup>

The variability of wind makes its integration into the electric system challenging, as illustrated by Figure 3-4, which shows the ramp rates of a wind farm in Texas. Taking a larger view, Figure 3-5 shows the chaotic day-to-day variability of a large wind farm's production over a month, along with the smoother long-term average. Energy storage can play an important balancing role in support of transmission system operations. Such balancing is currently being performed by gas turbines and other fossil-fueled generation systems. Integrating storage can produce value streams that include increased system capacity, transmission reservation, energy arbitrage, ancillary services, and renewable integration cost reduction.

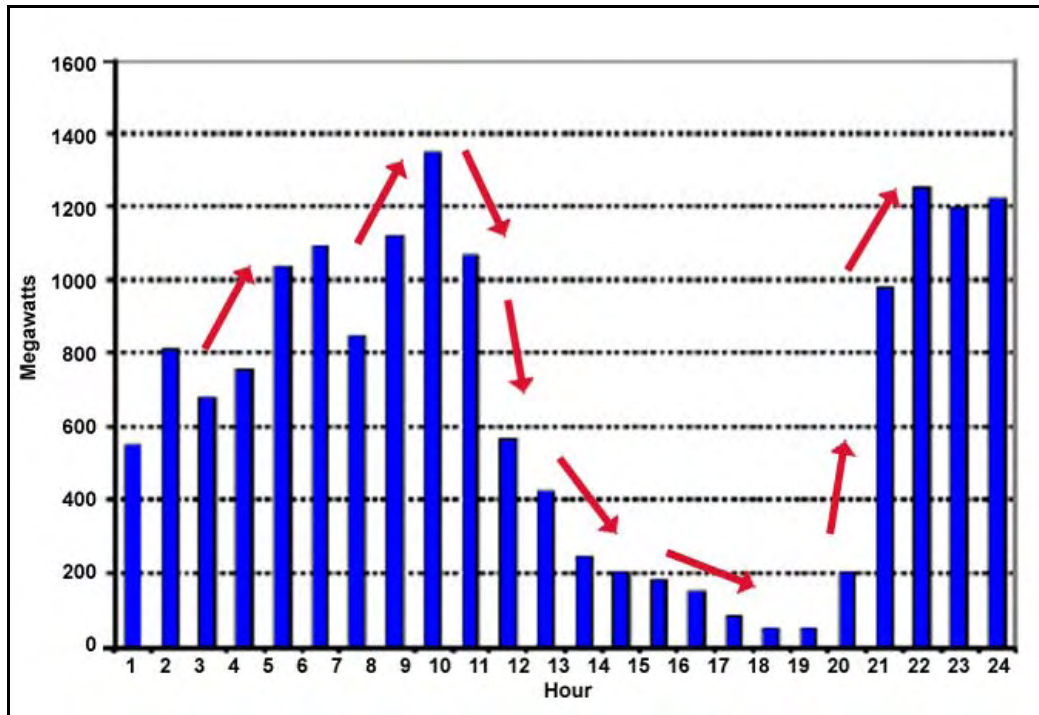

**Figure 3-4**  
**Sample Variability in Wind Farm Output over the Course of One Day (with arrows indicating ramp up and down)**

<sup>13</sup> *Economic and Greenhouse Gas Emission Assessment of Utilizing Energy Storage Systems in ERCOT*, EPRI, Palo Alto, CA: September 2009 (1017824).

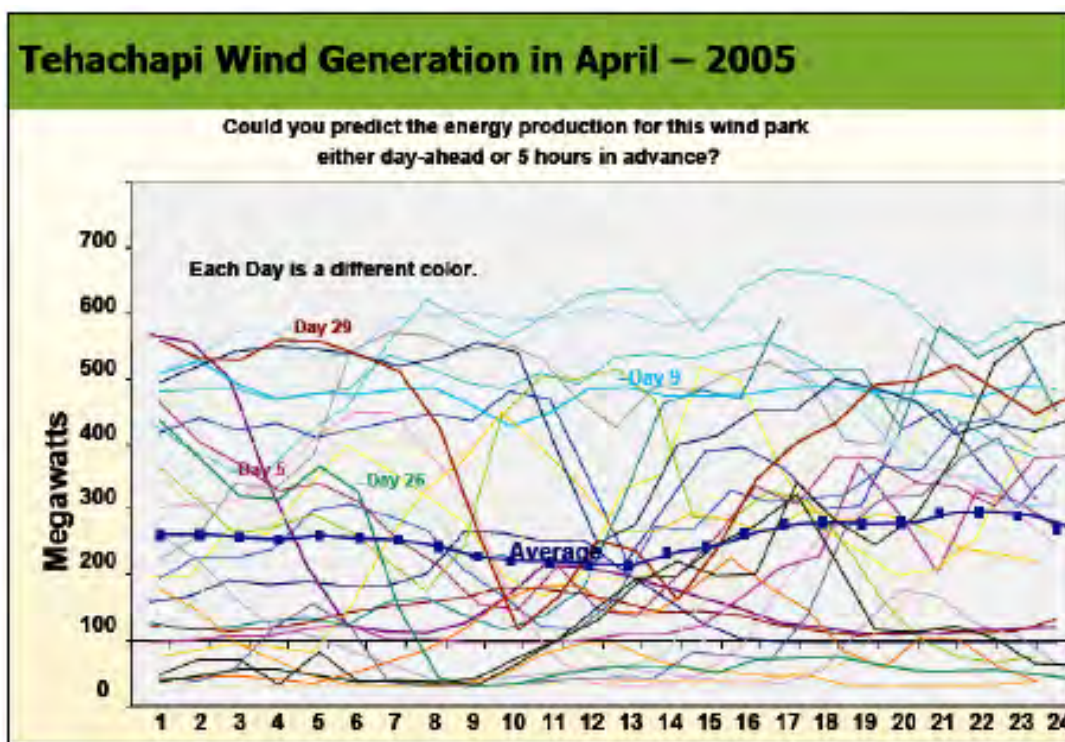

**Figure 3-5**  
Day-to-Day Variability in Wind Farm Output over One Month, with Average Indicated.

The 2010 CAISO *Renewable Integration* report describes how the California system will require increased ramp services in order to meet California's 33% renewable portfolio standard by 2020.<sup>14</sup> The ramp rate (MW/min) requirements are projected to double from 2006 to 2012, and then triple from 2012 to 2020. The actual ramp rate requirement varies by hour, but the system must be ready to procure the highest requirements. In addition, the report examines the load-following services required in California, meaning the incremental or decremental energy that ISOs dispatches in real time to manage the difference between the hour-ahead forecast and actual loads. The CAISO concluded that additional non-contingency load-following reserves will be needed to meet the 33% RPS requirements. The CAISO report notes that non-generation resources such as energy storage can meet these requirements.

Meeting wind integration requirements with fossil generation will result in added emissions associated with part-load operation of thermal plants when they are placed into the duty cycles needed to support renewables integration. Energy storage systems can partially mitigate such effects.

<sup>14</sup> *Discussion Paper Renewable Integration: Market and Product Review*. CAISO, July 2009, <http://www.caiso.com/27cd/27cdeb8548450.pdf>

Wind integration applications require both bulk storage capacities of 1 to 400+ MW for 4 to 10+ hours, and smaller 1- to 20-MW/15- to 60-min systems for smoothing and balancing. Technologies that appear compatible with those requirements include pumped hydro, compressed air energy storage (CAES) primarily with underground storage, large flow batteries such as zinc-bromine and vanadium redox systems, advanced lead-acid batteries, and lithium-ion battery and flywheel systems for fast response and smoothing.

### Photovoltaic Integration

Larger megawatt-scale photovoltaic installations will need energy storage due to the occurrence of large voltage sags and rapid demand shifts due to cloud effects. These effects can be even more severe than wind ramps because they are much faster. Rapid voltage excursions (Figure 3-6 below) present a significant challenge to utilities trying to integrate and manage these resources on their systems.

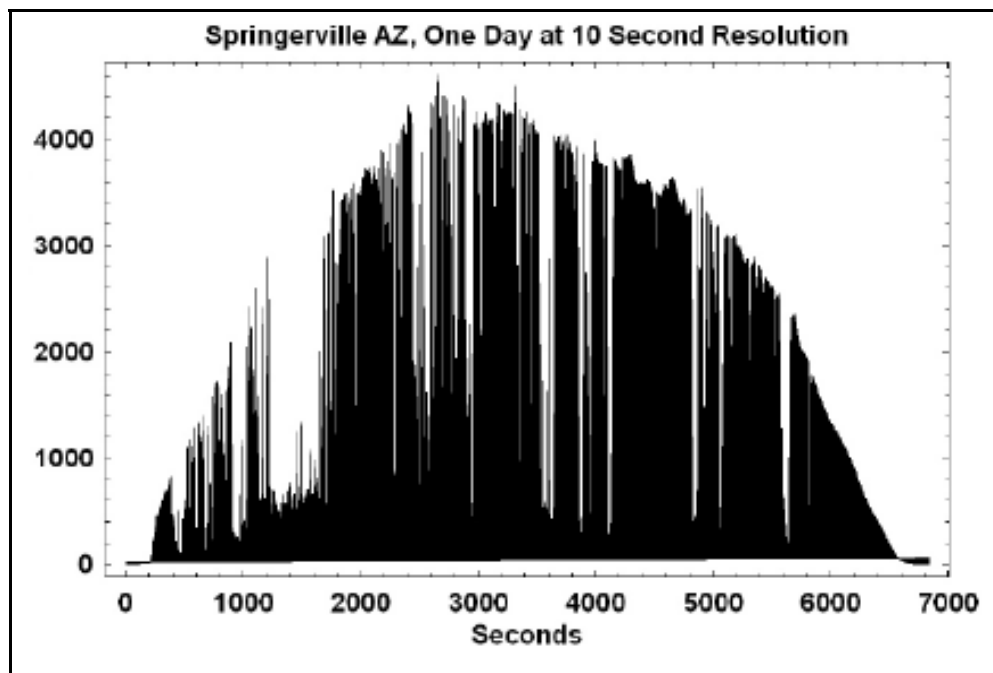

**Figure 3-6**  
**Output of Large Photovoltaic Power Plant over One Day, with Rapid Variability Due to Clouds**

In recent years, the increase of photovoltaic penetration on the distribution grid has presented operational problems for utilities. Energy storage systems can potentially alleviate voltage swings in the distribution grid. Large photovoltaic applications may also require high-power, low-energy storage systems that can perform many cycles and are capable of fast response. Such systems would generally be in the size range of 500 kW to 1



MW or larger with 15 minutes to 1 hr of storage, and could include advanced lead acid batteries, lithium-ion batteries, and super-capacitors.

**Table 3-1**  
**Estimated Market Sizes for System Integration Applications**

Application	Technical Market Potential (MW)	Target (Feasible) Market (MW)	High-Value Market (MW)
Wholesale Services with Regulation	4,310	3,450	1,790
Wholesale Services without Regulation	11,480	9,180	5,790
Remote Wind <sup>15</sup>	17,670	14,120	1,410
Wind & Photovoltaic	Not estimated	Not estimated	Not estimated

### **Utility Applications**

Managing grid peak loads in urban and rural load centers is a critical issue for the electric enterprise. Over the next 15 years, electric utilities will spend an estimated \$400 billion on new distribution infrastructure and \$200 billion on transmission infrastructure. These investments do not include additional costs for smart grid related investments or added transmission investments needed for new wind integration.

Researchers estimate that 25% of distribution and 10% of generation and transmission assets worth of hundreds of billions of dollars are needed less than 400 hours per year (Figure 3-7). This is particularly evident in the distribution area, where significant investments must be made to accommodate grid peak demands, which only occur about 400 to 500 hours per year. Energy storage systems offer electric utilities new options to improve the use and outlay of capital investments for new capacity, reliability, and grid support in rural and constrained urban areas.

T&D grid support solutions include:

- **Stationary Distribution Deferral:** Allows a two- to four-year capital deferral of new equipment such as transformers, as well as new lines in rural and urban areas where load growth is low and capital expenditures are very large.
- **Transportable Urban and Rural Distribution Deferral:** Similar benefits for two to four years using energy storage assets that can be transported to urban areas where they are needed most. Related applications include outage mitigation and improved restoration times.

<sup>15</sup> The Remote Wind application assumes that a storage device is located at a remote wind site to reduce the transmission capacity reservation, to arbitrage on-peak and off-peak energy prices, and to avoid integration costs that system operators may otherwise charge intermittent resources.

- ISO Congestion: Support at congested nodes in locations of marginal-priced markets. Benefits include increased load factor on congested transmission lines, frequency regulation, and storage assets applied on both the utility and customer sides of the meter for peak shaving and load shifting.

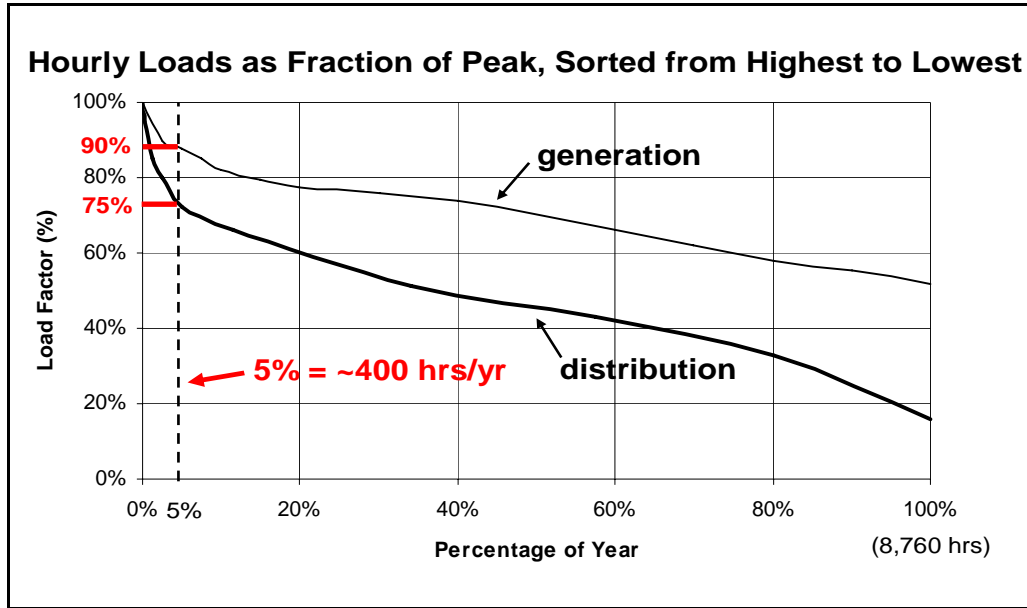

**Figure 3-7**  
**Significant Industry Investments in T&D Infrastructure are Required for Only**  
**Approximately 400 Hours per Year**

System requirements vary by applications and need. Substation support generally requires energy storage systems of 10+ MW for 4 to 6 hours. Transportable modular systems on the order of 1 MW/4 MWh could potentially be used for reliability and capital deferral, while ISO frequency regulation requires storage systems of a minimum of 1 MW—or aggregated systems that add up to 1 MW—with durations of 15 minutes or longer. Energy storage technology options include advanced lead-acid batteries, CAES with aboveground storage, sodium-sulfur, vanadium redox, and zinc-bromine batteries, lead-acid and advanced lead-acid batteries, Fe/Cr, Zn/air systems, and Li-ion batteries.

### ***Distributed Energy Storage Applications***

Distributed energy storage systems (DESS) involve small energy storage systems sited on the utility side of the meter, typically next to a pad-mounted transformer serving four to eight residences, a business park, a campus, or multi-family units (Figure 3-8 and Figure 3-9). Individual DESS units can be remotely controlled to manage their individual charge and discharge activity in response to regional need at the circuit, substation, or system level. Such units are envisioned to support grid peak loads in the summer months and provide backup support as needed.



**Figure 3-8**  
**Concept of a Neighborhood using DESS (Source: AEP, EPRI)**

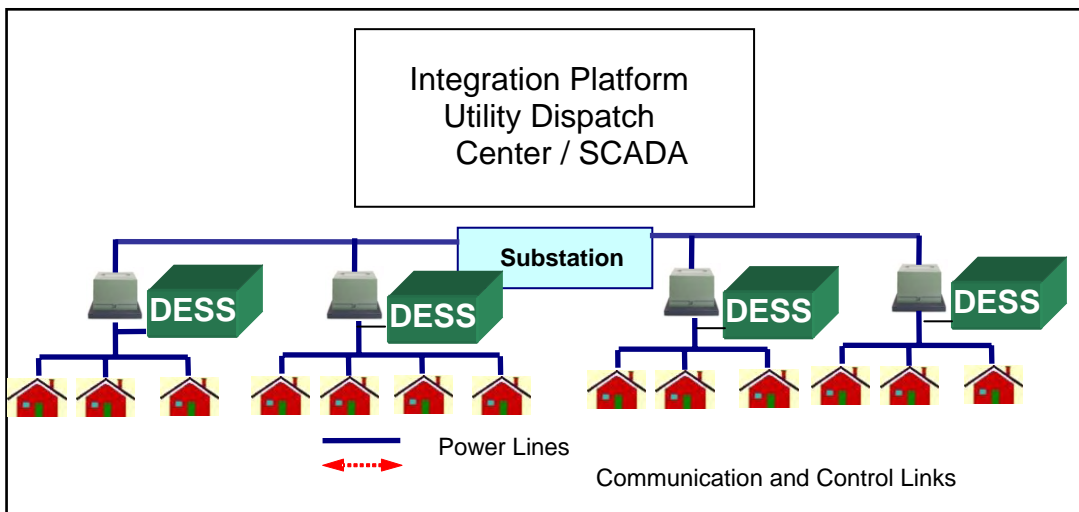

**Figure 3-9**  
**DESS Aggregation in Smart Grid Concept (Source: AEP, EPRI)**

While the definition and specification of DESS systems are still evolving,<sup>16</sup> individual DESS units might typically have nominal capacities of 25 to 50 kW with 2 to 4 hours of storage capability. The vision is that electric utilities would control, manage and aggregate the DESS units using an integration platform to provide large-scale grid support management. However, other business models may also emerge in which systems are owned by cities or third parties. To employ DESS, utilities will require storage devices with low cost, long life (15 years or more), low maintenance, and a small footprint. Technology options include advanced lead-acid, lithium-ion, and flow type batteries.

<sup>16</sup> *Functional Requirements for Electric Energy Storage Applications on the Power System Grid*, EPRI, Palo Alto, CA, 2010. 1020075

**Table 3-2  
Estimated Market Sizes for Utility Applications**

Application	Technical Market Potential (MW)	Target (Feasible) Market (MW)	High-Value Market (MW)
Commercial DESS	15,660	3,130	160
Industrial DESS	10,100	2,530	130
Stationary T&D Deferral	2,830	2,160	115
Stationary Distribution Deferral	7,170	5,730	1,150
Transportable T&D Deferral	4,310	3,440	170
Transportable Distribution Deferral	10,750	8,600	1,790

**Commercial & Industrial Applications**

The technical market for this application is composed of customers that highly value reliability and power quality. These commercial and industrial end users typically require uninterrupted power supply (UPS) or use back-up generators. The market for C&I energy management consists of customers on high time-of-use (TOU) electricity rates or high demand charges whose electricity consumption is also characterized by a low load factor. Interesting future markets could include dispatchable UPS systems for energy management and replacement of certain back-up diesel generators.

**Figure 3-10  
Estimated Market Sizes for C&I Applications**

Application	Technical Market Potential (MW)	Target (Feasible) Market (MW)	High-Value Market (MW)
Commercial PQ & Reliability	15,660	5,480	1,370
Industrial PQ & Reliability	10,100	3,540	1,770
Commercial Energy Mgt	5,280	1,850	90
Industrial Energy Mgt	20,400	7,140	360

## Residential Applications



**Figure 3-11**  
Residential Rooftop Photovoltaic Panels (Source: NREL)

Drivers in the residential market segment include demand for home and home office reliability and back-up power, home energy management, and, in the future, fast-charging plug-in hybrid and all-electric vehicles. Energy storage could also be integrated into residential photovoltaic systems (Figure 3-11), where it would provide valuable time-shifting benefits to shift peak photovoltaic output approximately 4 hours later to coincide with grid peak demand in the late afternoon. In a typical residential application, small energy storage systems are sited on the customer side of the meter but could be managed by the utility or an energy services provider.

Energy storage units for residential applications would require systems with capacities of 1 to 10 kW for 2 to 4 hours, depending on the specific use. Technology options include lead-acid and advanced lead-acid batteries, lithium-ion, and potentially small redox systems. Aggregation of many units may be essential for supporting the business case and in capturing the benefits discussed in this report.

**Figure 3-12**  
Estimated Market Sizes for Residential Applications

Application	Technical Market Potential (MW)	Target (Feasible) Market (MW)	High-Value Market (MW)
Home Back-Up	78,730	27,560	2,760
Home Energy Mgt	23,300	8,160	280
ESCO/Utility Aggregation	78,730	11,810	300

## Market Size Summary

Results of the market sizing analysis are summarized in Figure 3-13, which shows the estimated current U.S. market size for each energy storage application expressed as an estimate of technical market potential and a smaller “feasible” potential based on assumed adoption rates.

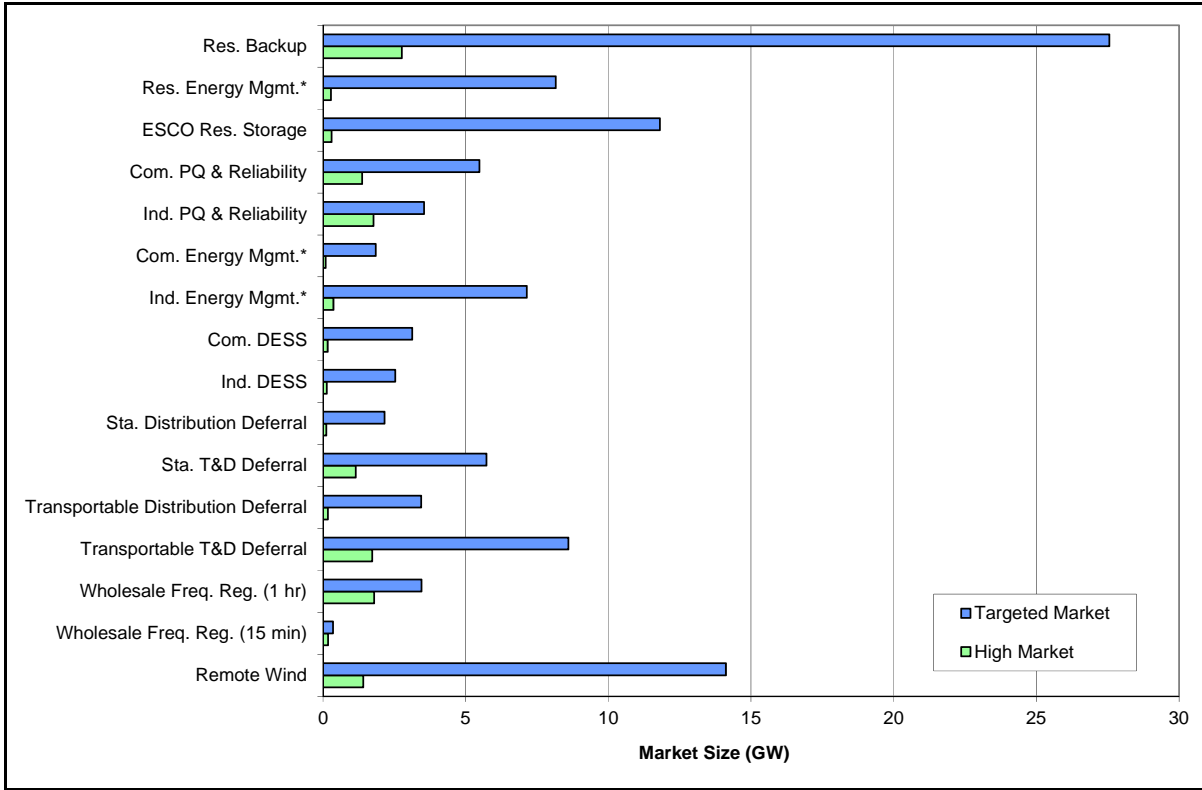

**Figure 3-13**  
Targeted vs. High Value Market Size by Application

As before, all values are presented from the regional (TRC) perspective except for the end-use energy management applications (*indicated in the figure with an asterisk*), which reflect the customer perspective and include bill savings that represent a loss of revenue to utilities.

Figure 3-14 shows the results of combining the market size study and value analysis based on EPRI’s models. Target market size is on the x-axis and the application value in present value (PV) \$/kW-h is on the y-axis. The figure also provides insights on market entry opportunities, as well as the total market size at particular price points. For example, at a price point of about \$700/kW-h, the potential market size for energy storage is estimated to be approximately 14 GW.

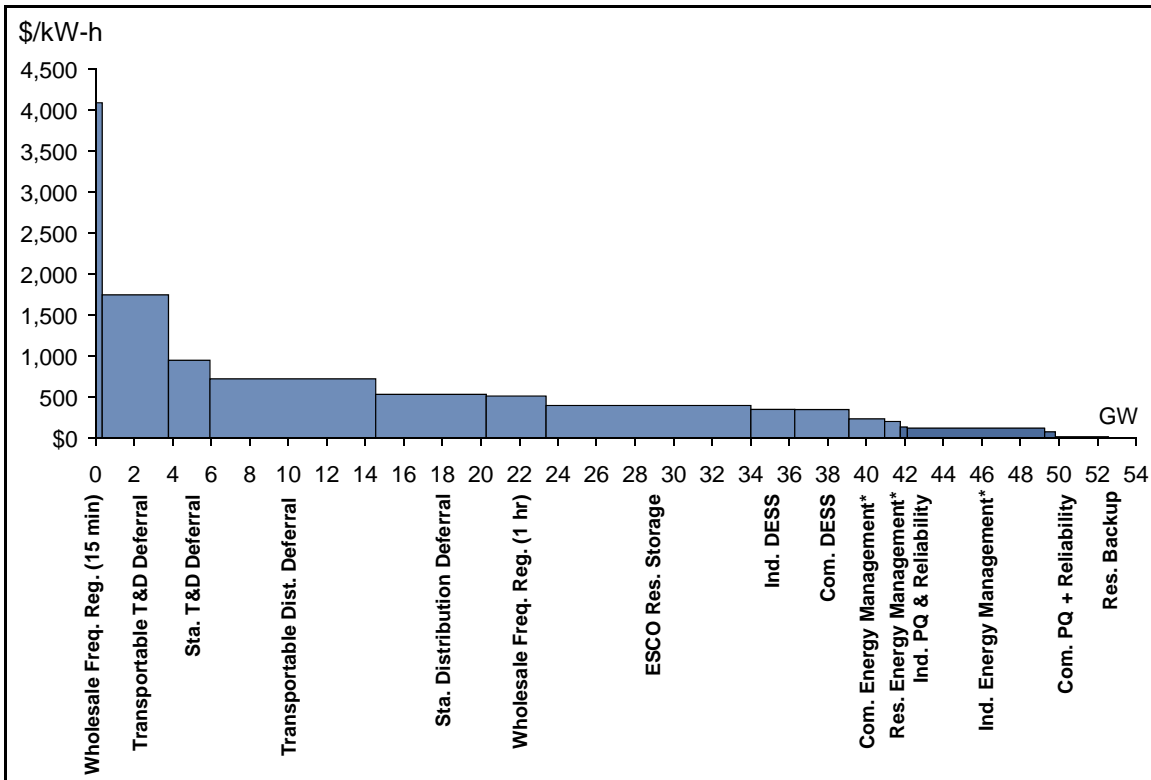

**Figure 3-14**  
**Estimated Target Market Size and Target Value Analysis**

Additional analysis was done on niche high-value applications, as shown in Figure 3-15 (note the different scales on both the X and Y axes). The results indicate that high-value applications represent much smaller markets, and could be viewed as initial niche entry opportunities for energy storage systems. In the near term, niche high-value markets were estimated to total approximately 2.5 GW if energy storage systems could be installed for \$1000/kW-h and all benefits could be monetized.

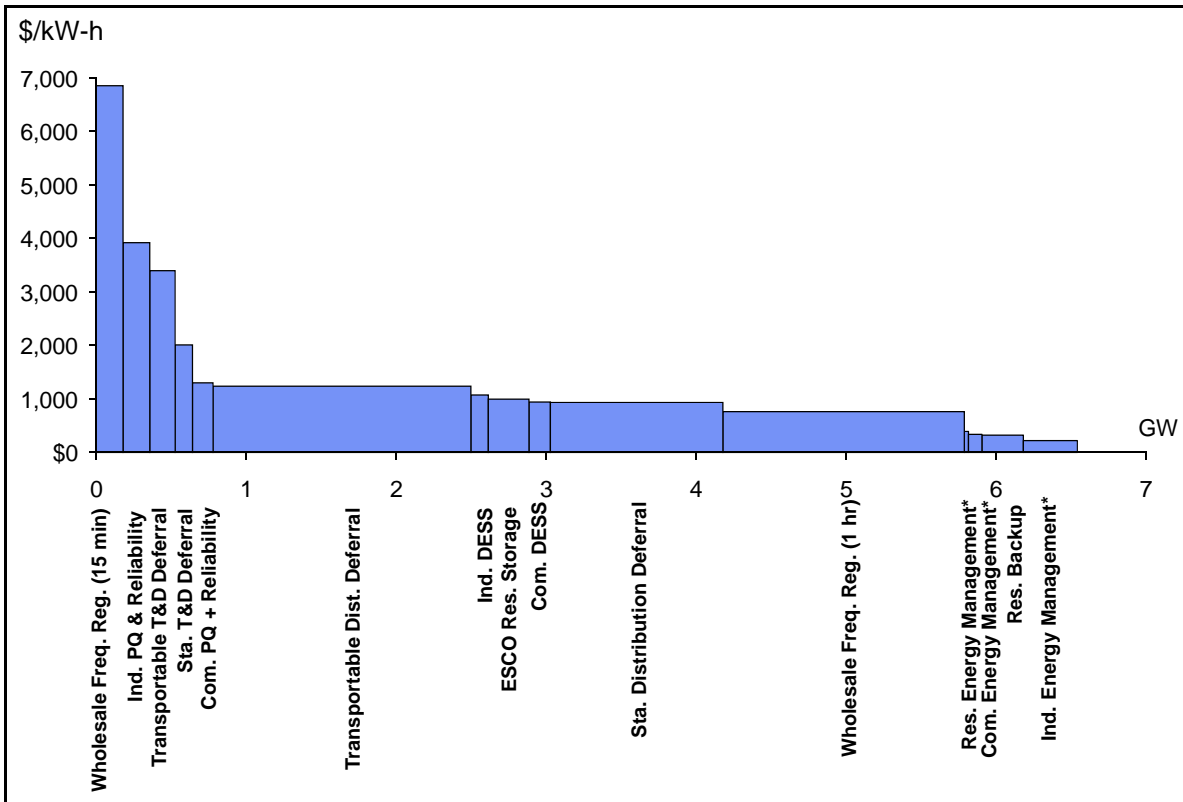

**Figure 3-15**  
**High-Value Market Energy Storage Supply Curve**

### Comparison to Alternative Energy Storage Market Size Approaches

As mentioned in Chapter 2, in 2010 Sandia National Laboratories published a prominent relevant report, *Energy Storage for the Electricity Grid: Benefits and Market Potential Assessment Guide*. EPRI’s and Sandia’s approaches to market sizing analysis differ based on framework (top-down vs. bottom-up), time horizon, and applications.

The research reported in this white paper is a result of a bottom-up assessment of the market for energy storage in the United States. For example, this analysis determines the potential market for home energy management by examining regional values for time-of-use rates, large home sizes, and energy efficiency measure adoptions rates. As much as possible, the analysis attempts to achieve the same level of detail in its market sizing for all ISO regions in the United States. The Sandia report utilizes a different approach in that it is strictly a top-down assessment. For most markets, Sandia’s analysis makes assumptions regarding what percent of a given customer class or end-use load would be a viable market for energy storage. The Sandia approach applies simple rules to arrive at general conclusions, while the methods used in this report provides a greater level of detail in their approach to estimating market size.



The time horizon for market potentials also differ. The Sandia report is a market technical potential assessment forecasted 10 years into the future. In contrast, the results presented in this report estimate technical potential today and go on to calculate a target and high-value market potential based on early adoption assumptions of storage system by application.

Finally, the Sandia market size analysis is based on benefit values, whereas the market size analysis presented in this white paper is based on defined storage applications. This report defines applications in order to allow modeling of a single storage device that accrues multiple benefit values—in particular, functioning in both energy mode and capacity mode depending on grid and customer conditions. In contrast, the Sandia report does not attempt to model an application in which the storage device is utilized in multiple modes of operation. EPRI’s approach assumes that energy storage applications will compete to participate in markets, such as the regulation market, and further assumes that the applications able to aggregate the highest values applications will dominate those markets. This subsumed market analysis is done in order to ensure that storage benefits are not double-counted when calculating market size. The Sandia report provides a comprehensive analysis of which benefit values could be accrued simultaneously but does not explicitly include this analysis in the market size component of the report.

## **Market Rules and Impact on Energy Storage Value**

Changing ISO market rules and product definitions have a potentially significant impact on the value of certain storage benefits. For example, until recently, regulation requirements that were designed with traditional fossil generation resources in mind required a minimum of 1 hour of energy delivery capability to participate in regulation markets. Such a requirement has not been a limiting factor for traditional generation, but can be for non-traditional generation resource such as energy storage. FERC Orders 890 and 719 required ISOs to modify their tariffs and market rules so all non-generating resources, such as demand response and energy storage, can fully participate in established markets alongside traditional generators. In response, ISOs are in various stages of implementing rule changes and pilot projects that will allow storage to provide 1 MW of regulation with as little as 15 minutes (or 250 kW-h) of energy delivery capacity. This improves the economics significantly for technologies such as flywheels and Li-ion, for which energy storage capacity (kW-h) is the most costly element of the storage system.

To accommodate limited energy delivery and take advantage of faster response and ramp rates, some ISOs are employing modified dispatch algorithms for non-generation or limited energy resources. These modifications include providing a frequency-only-based signal (PJM), eliminating the requirement to bid regulation resources into the energy market (NYISO), active ISO control of the energy storage level to maximize regulation capacity (NYISO), dispatching fast-responding resources first (ISONE, NYISO) and providing mileage or pay-for-performance payments (ISONE). Energy-neutral dispatch and compensation for fast response provide particularly attractive opportunities for energy storage, which is often limited either by technology or economics in the amount of energy

that can be provided. Implementing some of these modified rules has the potential to dramatically increase potential revenues on a \$/kW-h basis from roughly \$1,000/kW-h to over \$6,000/kW-h in some markets (Figure 3-16).

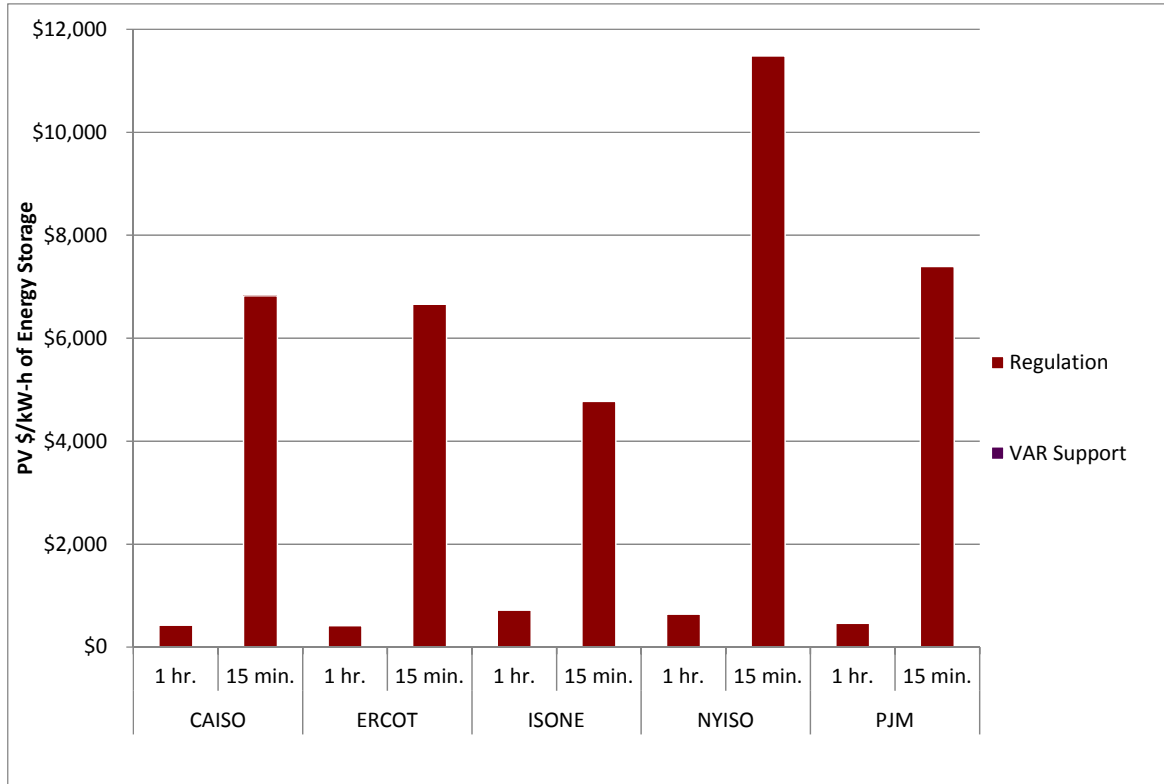

**Figure 3-16**  
**Regulation with 15 Minutes vs. 1 Hour of Energy Storage**

Battery companies have also argued that storage systems can respond much faster to regulation signals than traditional fossil and hydro generation, and therefore provide greater value. One source of evidence cited is the Pacific Northwest National Laboratory report *Assessing the Value of Regulation Resources Based on Their Time Response Characteristics* (PNNL 2008a), which found that a fast regulation device with limited energy is 1.7 times more efficient than the existing mix of resources providing regulation in the CAISO, and 2.24 times more efficient than a combustion turbine. Other studies have shown that fast or frequency regulation provided by energy storage can reduce emissions and operating costs for natural-gas-fired generation.<sup>17</sup>

If ISOs recognize and price the value of fast regulation in future markets, regulation revenues for energy storage devices could increase a commensurate amount. Separate markets for regulation-up and regulation-down also provide increased revenue potential for

<sup>17</sup> *Emissions Comparison for a 20 MW Flywheel-based Frequency Regulation Power Plant*, KEMA, Raleigh, NC: January 2007 (Project: BPCC.0003.001)

energy storage compared to a single regulation market, which requires providers to maintain the capability to provide the regulation quantity bid in both the up (discharge) and down (charge) directions. This is not a not a serious limitation to traditional generation but can significantly reduce revenues for energy storage.

With separate markets, such as those in CAISO and ERCOT, storage can bid into the regulation market in one direction during those hours when it is near empty or full, or fully charging or discharging. While such a market design is advantageous for storage, moving to a bi-directional regulation market requires major changes to software systems and is not currently under consideration by any ISOs with a single regulation market

### **Future Markets**

Anticipated changes in future markets may also provide additional revenue potential for energy storage. Though the timing and magnitude of the impacts are difficult to predict, these changes include:

**Increased Volatility in Energy Prices:** Increasing penetration of wind generation is expected to increase the volatility of energy prices in several markets. Wind generation tends to peak during the night. In many regions, it will exert downward pressure on already lower off-peak energy prices. For example, the frequency of negative prices during off-peak periods in ERCOT has increased dramatically since 2006 as wind generation has increased. This volatility has the potential to improve energy arbitrage revenues from energy storage.

**Renewable Integration:** Multiple integration studies have suggested that the challenge of integrating renewables increases in a non-linear fashion as penetration levels exceed 20%. The CAISO *Integration of Renewable Resources* study<sup>18</sup> found that the maximum regulation-up requirement will increase 35% from 278 MW in 2006 to 502 MW in 2012 and then increase an additional 180% to 1,444 MW in 2020. The maximum load-following down-requirement is expected to roughly double from 2006 to 2012 over most of the year. It does not necessarily follow that prices will increase proportional to demand, however, as they are determined primarily by variable operating and fuel costs.

**High-Penetration Photovoltaic Generation:** Distribution engineers anticipate increasing challenges managing high penetrations of solar photovoltaics on the local distribution system. Energy storage systems can provide local voltage and VAR support, and manage intermittent variation in photovoltaic loads. These benefits will certainly have value where solar generation is concentrated on the distribution system, but that value is difficult to

---

<sup>18</sup> *Integration of Renewable Resources: Operational Requirements and Generation Fleet Capability at 20% RPS*, California Independent System Operator: August 31, 2010.

quantify as alternative strategies for managing concentrated photovoltaics are still being developed.

**Demand-Side Competition:** Demand response and other load-management strategies are also vying for the small but lucrative regulation market. The regulation market for the entire United States is less than 1% of industrial load. It is entirely possible that alternative load management technologies will saturate the regulation market even as the size of the market increases to meet wind integration. Load management could also potentially provide large quantities of the ramp and load following that will be required to integrate renewable generation. Load management opportunities are not necessarily dependent on AMI and smart grid networks, but could be significantly enhanced by their deployment.

**Commercial and Energy Management:** In addition to the markets discussed in this report, future markets could emerge with the replacement of existing back-up generation, large UPS systems, or co-location with high-efficiency distributed generation systems such as fuel cells. As lower cost energy storage systems develop, these markets and applications could emerge and create new channels for adopting embedded energy storage systems.

### ***Storage as Transmission***

In some cases, storage providers have applied to FERC or their respective ISOs to be considered a transmission asset, with cost recovery included in transmission or grid charges. Proponents have argued that batteries serve a reliability function and are similar to substation equipment, such as large electricity capacitors, which are used in many wholesale transmission system facilities (FERC 2009). FERC has approved the inclusion of storage as a transmission asset in some cases, including a sodium-sulfur battery proposed by Electric Transmission Texas (ETT) in Presidio, Texas (Isser 2010), and three sodium-sulfur installations proposed by the Western Grid Development LLC (WGD) for specific sites on the CAISO grid.

FERC has been careful to limit its rulings to the specific assets in question, based on the reliability and operational benefits they provide to the grid. For the WGD proposal, all FERC incentives were approved on the condition that CAISO approve the projects as part of its transmission planning process.

Market rules generally prohibit transmission assets from participating in wholesale energy and ancillary service markets to maintain the independence of grid operators and avoid the potential for market manipulation, whether real or perceived. This clear distinction between transmission and generation assets is problematic for storage. As shown above, regulation is a particularly valuable benefit that storage can provide. In addition, it is not clear how storage is to procure and discharge energy outside the wholesale energy markets. The ETT Presidio project was ultimately completed in 2010, but only after extensive legal and regulatory consideration.

The WGD sodium-sulfur batteries have been opposed by the CAISO on the basis that, unlike capacitors and other substation equipment, storage can participate in competitive markets. The CAISO also argued that guaranteed cost recovery will place independent projects with similar characteristics at a competitive disadvantage. In addition, the CAISO maintained that placing storage assets under ISO operational control raises issues with respect to the independence of the ISO and market participants' perception of the ISO's neutrality.

The lack of clarity regarding the ownership, asset classification, and market participation rules for energy storage is often cited as a significant impediment for storage adoption. FERC indicated that in the future it will address the classification of energy storage devices on a case-by-case basis. The potential for energy storage technology to operate as a transmission facility is a significant business opportunity for storage technology. Transmission incentives present energy storage technologies with favorable financing opportunities, but may prevent them from realizing the multiple simultaneous benefit values identified in this report.



# 4

## TECHNOLOGY OPTIONS: ENERGY STORAGE SOLUTIONS AND SYSTEM COSTS

---

### Energy Storage Solutions and Options

This section reviews the current status of energy storage options and provides updated estimate ranges for their total installed costs, performance, and availability for key applications. Estimates are based on technology assessments and discussions with vendors, system integrators and utilities, as well as experience with installed operating systems. Data presented represent “averaged values” from multiple sources. For each technology, process and project contingencies are provided. *Process* contingencies address uncertainties in system performance, efficiency, and system integration. *Project* contingencies reflect uncertainties in performance, siting, construction and initial start-up and operation costs. This chapter provides:

- Descriptions of each technology option, including a summary of commercial and development status
- Current technology performance and costs for each option
- Discussion of future development directions and trends
- Development and commercialization timelines for emerging systems.

Table 4-1 summarizes the development status of leading energy storage options.

**Table 4-1**  
**Energy Storage Technologies Classified by Development Status**

Letter Rating	Key Word	Example Technology Options
A	Mature	Pumped hydro, lead-acid battery
B	Commercial	CAES first generation, Lead-acid, NiCd, sodium-sulfur batteries
C	Demonstration	CAES second generation, Zn/Br, vanadium redox, NiMH, advanced lead-acid, Li-ion
D	Pilot	Li-ion, Fe/Cr, NaNiCl <sub>2</sub>
E	Laboratory	Zn/air, Zn-Cl, advanced Li-ion, novel battery chemistries
F	Idea	Non-fuel (“adiabatic”) CAES, nano-supercapacitors, other novel battery chemistries.

## Pumped Hydro

Pumped hydroelectric energy storage is a large, mature, and commercial utility-scale technology currently used at many locations in the United States and around the world. Pumped hydro employs off-peak electricity to pump water from a reservoir up to another reservoir at a higher elevation. When electricity is needed, water is released from the high reservoir through a hydroelectric turbine into the low reservoir to generate electricity (Figure 4-1). This application has the highest capacity of the energy storage technologies assessed, since its size is limited only by the size of the available upper reservoir.

**Table 4-2**  
**Technology Dashboard: Pumped Hydro**

<b>Technology Development Status</b>	Mature	Numerous New Pumped Hydro FERC Filings in U.S.
<b>Confidence of Cost Estimate</b>	C	Preliminary: Site-specific
<b>Accuracy Range</b>	C	-20% to +25%
<b>Operating Field Units</b>	20 units (40 GW) in U.S.	Over 129 GW in operation worldwide
<b>Process Contingency</b>	0%	Variable-speed drive technology being applied to new sites
<b>Project Contingency</b>	10-15%	Uncertainties in siting, permitting, environmental impact and construction

Projects may be practically sized up to 4000 MW and operate at about 76%–85% efficiency depending on design. Pumped hydro plants have very long lives on the order of 50 years, and fast response times that enable them to participate equally well in voltage and frequency regulation, spinning reserve, and non-spinning reserves markets, as well as energy arbitrage and system capacity support.

While the siting, permitting, and associated environmental impact processes can take many years, there is growing interest in re-examining opportunities for pumped hydro in the United States, particularly in view of the large amounts of wind generation and new nuclear power generation that may be deployed over the next few decades. Figure 4-2 illustrates the active permits for new pumped hydro facilities. In 2011, EPRI is undertaking research to better estimate the future costs of building new pumped hydro facilities.



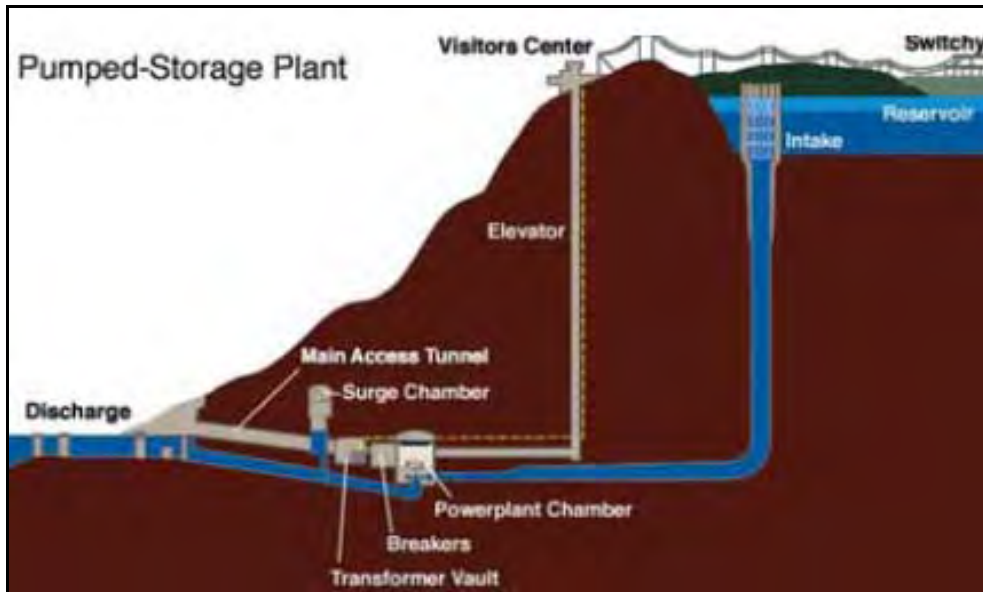

Figure 4-1  
Cutaway Diagram of a Typical Pumped Hydro Plant



Figure 4-2  
Active FERC Permits for Pumped Hydro Filings in the United States



**Figure 4-3**  
**Manmade Upper Reservoir of TVA's Raccoon Mountain Pumped Hydro Plant.**  
**Operational in 1979, the facility can generate 1620 MW for up to 22 hours.**

### **Compressed Air Energy Storage (CAES)**

CAES uses off-peak electricity to compress air and store it in a reservoir, either an underground cavern or aboveground pipes or vessels. When electricity is needed, the compressed air is heated, expanded, and directed through a conventional turbine-generator to produce electricity.

**Table 4-3**  
**Technology Dashboard: CAES (Second Generation)**

<b>Technology Development Status</b>	Pre-Commercial	System to be verified by demonstration unit
<b>Confidence of Cost Estimate</b>	C	Preliminary
<b>Accuracy Range</b>	C	-20% to +25%
<b>Operating Field Units</b>	None	Two of first generation type
<b>Process Contingency</b>	10-15%	Primarily for the CT-based CAES cycles as this cycle has yet to be demonstrated. Key components and controls need to be verified for second-generation systems, including controls to enable dispatch in ancillary service markets
<b>Project Contingency</b>	10%	Plant costs will vary depending underground site geology

There are two operating first-generation systems: one in Germany and one in Alabama. In the past two years, improved second-generation CAES systems have been defined and

are being designed that have potential for lower installed costs, higher efficiency, and faster construction time than first-generation systems. In one type of advanced second-generation CAES plant, a natural-gas-fired combustion turbine (CT) is used to generate heat during the expansion process, and two-thirds of the electricity generated is produced during the “green” compressed air cycle. New compressor designs and advanced turbo machinery are also leading to improved non-CT-based CAES systems.

In late 2009, DOE awarded smart grid matching grants for the construction of 150-MW/10-hour and 300-MW/10-hour advanced second-generation CT-CAES units to New York State Electric & Gas and PG&E, respectively. An emerging advanced concept still under research and development called “adiabatic CAES” (A-CAES) consumes little or no fossil fuel or external energy, instead drawing heat needed during expansion from thermal energy captured during compression. An aboveground demonstration of an A-CAES system could materialize by 2015.

Underground CAES storage systems are most cost-effective with storage capacities up to 400 MW and discharge times of 8 to 26 hours. Siting such plants involves finding and verifying the air storage integrity of a geologic formation appropriate for CAES in a given utility’s service territory. As shown in Figure 4-4, much of the United States has potentially suitable geology. CAES plants employing aboveground air storage would typically be smaller than plants with underground storage, with capacities on the order of 3 to 15 MW and discharge times of 2 to 4 hours. Aboveground CAES plants are easier to site but more expensive to build (on a \$/kW basis) than CAES plants utilizing underground air storage systems, primarily due to the incremental additional cost associated with aboveground storage. CAES systems utilizing improved first-generation designs also continue to be evaluated and are being proposed.

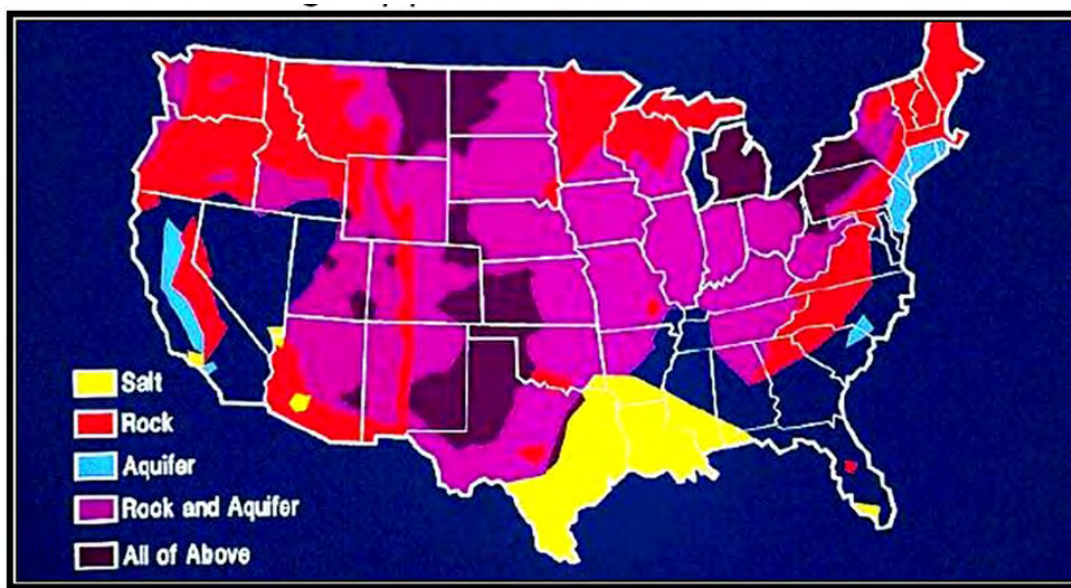

**Figure 4-4**  
Overview of geological formations in continental U.S., showing potential CAES siting opportunities based on EPRI geologic studies.

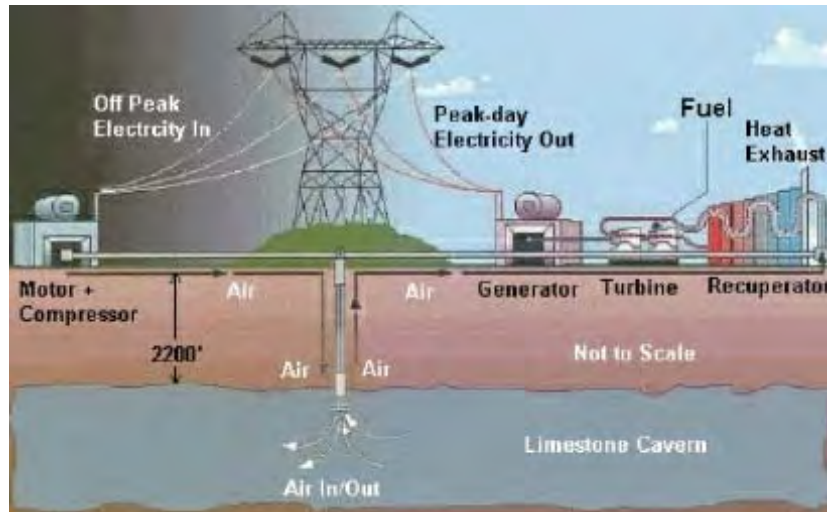

**Figure 4-5**  
Schematic of CAES plant with underground compressed air storage.



**Figure 4-6**  
Aerial View of an underground CAES plant in McIntosh, Alabama, one of two such facilities operating in the world. The other is in Huntorf, Germany.

### ***Lead-Acid Batteries***

Lead-acid is the most commercially mature rechargeable battery technology in the world. Valve-regulated lead-acid (VRLA) batteries are used in a variety of applications,

including automotive, marine, telecommunications, and UPS systems. There have been few utility T&D applications for such batteries due to their relatively heavy weight, large bulk, cycle-life limitations and perceived reliability issues (stemming from maintenance requirements).

**Table 4-4  
Technology Dashboard: Valve-Regulated Lead-Acid (VRLA) Battery Systems**

<b>Technology Development Status</b>	Mature A	Significant industrial and commercial experience.
<b>Confidence of Cost Estimate</b>	B	Vendor quotes and system integration costs.
<b>Accuracy Range</b>	C	-10% to +15%
<b>Operating Field Units</b>	5 or more in utility energy management	Thousands of units in UPS, back-up and certain energy management applications. Limited utility grid-scale applications.
<b>Process Contingency</b>	0%	
<b>Project Contingency</b>	5%	Cycle life, kWh per cycle, and depth of discharge for specific use needs careful evaluation when planning an application.



**Figure 4-7  
1-MW/1.5-MWh Lead-Acid System at Metlakalta, Alaska**

Power output from lead-acid batteries is non-linear and their lifetime varies significantly depending on the application, discharge rate, and number of deep discharge cycles, which can significantly reduce life. A 1-MW/1.5-MWh lead-acid system by GNB Industrial Power and Exide has been operating for 12 years at a remote island location in Alaska (Figure 4-7). In that project, the battery system exhibited very little visible degradation upon post-test analysis and was replaced in 2008. Other lead-acid energy systems have been deployed in sizes of 10 to 20 MW. Battery price can be influenced by the cost of lead, which is a commodity. Finally, very limited data is available on the operation and maintenance costs of lead-acid based storage systems for grid support.

### Advanced Lead-Acid Batteries

Work to improve lead-acid battery technology and materials continues. Innovation in materials is improving cycle life and durability, and several advanced lead-acid technologies are being developed are in the pre-commercial and early deployment phase. These systems are being developed for peak shaving, frequency regulation, wind integration, photovoltaic smoothing and automotive applications.

Some advanced lead batteries have “supercapacitor-like” features that give them fast response similar to flywheels and supercapacitors. Advanced lead-acid systems from a number of companies are anticipated to be in early field trial demonstrations by 2011–2012.

**Table 4-5  
Technology Dashboard: Advanced Lead-Acid Battery Systems**

<b>Technology Development Status</b>	Demonstration C	Limited field demonstrations
<b>Confidence of Cost Estimate</b>	D	Vendor quotes and system installation estimates.
<b>Accuracy Range</b>	C	-10% to +15%
<b>Operating Field Units</b>	2 or more	Several wind and photovoltaic applications expected by 2011
<b>Process Contingency</b>	10-15%	Limited testing and filed experience
<b>Project Contingency</b>	5-10%	Cycle life and depth of discharge for application needs careful evaluation; limited operation and maintenance cost data



**Figure 4-8  
Phase 1 of Ecoult 1-MW/1-MWh UltraBattery system at Hampton Wind Smoothing Project in Australia (Source: Ecoult).**



**Figure 4-9**  
**1.5-MW/1-MWh Advanced Lead Acid “Dry Cell” Systems by Xtreme Power being deployed in a wind farm application (Source: Xtreme Power).**

### **Sodium-Sulfur (NaS)**

Sodium-sulfur batteries are a commercial energy storage technology finding applications in electric utility distribution grid support, wind power integration, and high-value service applications on islands. The round-trip ac-to-ac efficiency of sodium-sulfur systems is approximately 80%. The estimated life of a sodium-sulfur battery is approximately 15 years after 4500 cycles at 90% depth of discharge.

**Table 4-6**  
**Technology Dashboard: Sodium-Sulfur (NaS) Battery Systems**

<b>Technology Development Status</b>	Mature A	Significant recent commercial experience.
<b>Confidence of Cost Estimate</b>	A	Data based on installed systems.
<b>Accuracy Range</b>	B	-5% to +8%
<b>Operating Field Units</b>	221 sites	316 MW installed.
<b>Process Contingency</b>	0%	Proven battery performance
<b>Project Contingency</b>	1-5%	Depending on site conditions

Sodium-sulfur battery technology was jointly developed by NGK Insulators Ltd., and Tokyo Electric Power Co. (TEPCO) over the past 25 years. “NAS” is a registered

trademark for NGK's sodium-sulfur battery system, while "NaS" is a generic term for sodium-sulfur chemistry based on those elements' atomic symbols ("Na" and "S").



**Figure 4-10**  
**NYPA 1.2-MW/7.2-MWh Sodium-Sulfur Battery Facility**



**Figure 4-11**  
**AEP Distribution Substation with Sodium-Sulfur Unit**

NGK Insulators' NAS installations providing the functional equivalent of about 160 MW of pumped hydro storage are currently deployed within Tokyo. NAS batteries are only available in multiples of 1-MW/6-MWh units with installations typically in the range of 2 to 10 MW. The largest single installation is the 34-MW Rokkasho wind-stabilization project in Northern Japan that has been operational since August 1, 2008. At this time, about 316 MW of NAS installations have been deployed globally, including 50 MW in Abu Dhabi. Agreements are in place to supply an additional 300 MW to customer(s) in Abu Dhabi and 150 MW to Electricite de France over the next few years. Customers in the United States include American Electric Power (11 MW deployed), PG&E (4 MW, in



progress), New York Power Authority (1 MW, deployed) and Xcel Energy (1 MW, deployed). An anonymous U.S. customer is in the process of deploying another 2 MW. All together, more than 316 MW are installed globally at 221 sites, representing 1896 MWh. Installed capacity is anticipated to grow to 606 MW (3636 MWh) by 2012.

### **Sodium Nickel Chloride**

While not analyzed and addressed in this report, there are large projects underway to advance sodium nickel chloride (NaNiCl<sub>2</sub>) battery technology for grid-ready applications. Suppliers in 2010 were not in a position to provide cost and performance data for grid-ready systems so this technology was excluded from EPRI's analysis at this time.

### **Vanadium Redox**

Vanadium redox batteries are a type of flow battery, and the most mature of all flow battery systems available. In flow batteries, energy is stored as charged ions in two separate tanks of electrolytes, one of which stores electrolyte for positive electrode reaction while the other stores electrolyte for negative electrode reaction. Vanadium redox systems are unique in that they use one common electrolyte, which provides potential opportunities for increased cycle life. When electricity is needed, the electrolyte flows to a redox cell with electrodes, and current is generated. The electrochemical reaction can be reversed by applying an overpotential, as with conventional batteries, allowing the system to be repeatedly discharged and recharged. Like other flow batteries, many variations of power capacity and energy storage are possible depending on the size of the electrolyte tanks.

**Table 4-7  
Technology Dashboard: Vanadium Flow Type Battery Systems**

<b>Technology Development Status</b>	Demonstration C	Systems verified in limited field demonstrations.
<b>Confidence of Cost Estimate</b>	C	Vendor quotes and system installation estimates.
<b>Accuracy Range</b>	C	-10% to +15%
<b>Operating Field Units</b>	Units operating in telecom applications	Currently 20 kWh–40 kWh systems operating in China, Europe, US, Africa and Middle East. Larger kWh demonstrations have been built but are currently not operating.
<b>Process Contingency</b>	5-8%	For MW-scale applications
<b>Project Contingency</b>	10-15%	For MW-scale applications Contingency will vary by size of the application.

Several vanadium redox systems have been deployed, including:

- A 15-kW/120-kWh unit operating over three years in a smart grid application by RISO in Denmark
- A 250-kW/2-MWh unit at Castle Valley, Utah by PacifiCorp, which operated 6 years before being discontinued when the application need changed.
- A 200-kW/800-kWh unit at King Island, Tasmania by HydroTasmania
- A 4-MW/6-MWh unit at Tomamae, Hokkaido, Japan by JPower
- Smaller 5-kW units that have been deployed in field trials.

Vanadium redox systems can be designed to provide energy for 2 hours to more than 8 hours depending on the application. The lifespan of flow-type batteries is not strongly affected by cycling. Suppliers of vanadium redox systems estimate lifespan of the cell stacks to be 15 or more years, while the balance of plant and electrolyte can have lifetimes of over 25 years. System suppliers also say they have achieved cycling capability of 10,000 or more cycles at 100% depth of discharge. The physical scale of vanadium redox systems tends to be large due to the large volumes of electrolyte required when sized for utility-scale (megawatt-hour) projects.



**Figure 4-12**  
Prudent Energy 5-kW/30-kWh VRB-ESS installed at Kitangi, Kenya works alongside a diesel generator to comprise a hybrid power system at an off-grid site.

### **Zinc-Bromine (Zn/Br)**

Zinc-bromine is a type of redox flow battery that uses zinc and bromine in solution to store energy as charged ions in tanks of electrolytes. As in vanadium redox systems, the

Zn/Br battery is charged and discharged in a reversible process as the electrolytes are pumped through a reactor vessel.

**Table 4-8  
Technology Dashboard: Zinc-Bromine Flow Type Battery Systems**

<b>Technology Development Status</b>	R&D and Demonstration phases C	Small systems verified in limited field demonstrations. Large utility-scale units are in the early demonstration phase
<b>Confidence of Cost Estimate</b>	C	Vendor quotes and system installation estimates.
<b>Accuracy Range</b>	C	-10% to +15%
<b>Operating Field Units</b>	3 or more	None in utility-scale demonstrations of 100 kW or larger.
<b>Process Contingency</b>	10-15%	Efficiency uncertain. Limited life and operating experience at greater than 100 kW.
<b>Project Contingency</b>	10- 15%	Transportable and small systems have lower construction and installation issues.



**Figure 4-13  
These 5-kW/20-kWh Community Energy Storage (CES) Systems by RedFlow Power and Ergon Energy of Australia will be linked by a Smart Grid network to provide megawatt-scale storage on the electricity grid.**

Zn/Br batteries are in an early stage of field deployment and demonstration, and are less developmentally mature than vanadium redox systems. While field experience is currently limited, vendors claim estimated lifetimes of 20 years, long cycle lives, and operational ac-to-ac efficiencies of approximately 65% to 70%.

Module sizes vary by manufacturer but can range from 5 kW to 500 kW, with variable energy storage duration from 2 to 6 hours, depending on the application and need. Small

projects comprising 5-kW/2-hour systems are being deployed in rural Australia as an alternative to installing new power lines. In the United States, electric utilities plan to conduct early trials of 0.5-MW/2.8-MWh transportable systems for grid support and reliability. The first 0.5-MW systems are expected to be deployed in early 2011 by EPRI and a consortium of electric utilities.



**Figure 4-14**  
**Premium Power's 0.5-MW/2.8 MWh TransFlow 2000 Transportable Zinc-Bromine Energy Storage System, to be tested by EPRI and a utility consortium.**

### ***Fe/Cr and Zn/Air***

Fe/Cr and Zn/air redox systems are still in the laboratory R&D stage but are rapidly advancing. The low-cost structure of these systems also makes them worth evaluating for grid-storage solutions. Given the considerable uncertainties in performance and cycle life, process and project contingencies are high.

**Table 4-9**  
**Technology Dashboard: Fe/Cr and Zn/air Battery Systems**

<b>Technology Development Status</b>	Laboratory E	Small cells and stack in a lab setting
<b>Confidence of Cost Estimate</b>	C	Vendor quotes and system installation estimates.
<b>Accuracy Range</b>	E	-10% to +15%
<b>Operating Field Units</b>	None	None in utility-scale demonstrations of Fe/Cr in niche telecom applications
<b>Process Contingency</b>	15-20%	Efficiency and cycle life uncertain. Scale-up uncertainties
<b>Project Contingency</b>	10-15%	Limited definition of product designs.

## Flywheels

Flywheels are shorter energy duration systems that are not generally attractive for large-scale grid support applications, which require many kilowatt-hours or megawatt-hours of energy storage. They operate by storing kinetic energy in a spinning rotor made of advanced high-strength materials that is charged and discharged through a generator.

**Table 4-10**  
**Technology Dashboard: Flywheel Energy Storage Systems**

<b>Technology Development Status</b>	Demonstration status for Frequency Regulation C	Commercial experience in Power Quality UPS applications
<b>Confidence of Cost Estimate</b>	B	Vendor quotes and system installation estimates.
<b>Accuracy Range</b>	B	-10% to +15%
<b>Operating Field Units</b>	10 or more	In a 1 MW application. Numerous uses in power quality applications.
<b>Process Contingency</b>	1-5%	Uncertain long-term life and performance.
<b>Project Contingency</b>	5-10%	

Flywheels charge by drawing electricity from the grid to increase rotational speed, and discharge by generating electricity as the wheel's rotation slows. They have a very fast response time of 4 milliseconds or less, can be sized between 100 kW and 1650 kW, and may be used for short durations of up to 1 hour. They also have very high efficiencies of about 93%, with lifetimes estimated at 20 years.

Although flywheels have power densities 5 to 10 times that of batteries—meaning they require much less space to store a comparable amount of power—there are practical limitations to the amount of energy (kW-h) that can be stored. A flywheel energy storage plant can be scaled up by adding more flywheel system modules. Typical flywheel applications include power quality and uninterruptible power supply (UPS) uses, as seen in commercial products offered by Pentadyne (Figure 4-15). Research is also underway to develop more advanced flywheel systems that can store large quantities of energy, but these developments are at least 4 or 5 years from a large-scale utility demonstration.



**Figure 4-15**  
**Pentadyne GTX Flywheel**

Because flywheel systems are fast responding and efficient, they are being positioned to provide ISO frequency regulation services. Analysis of such flywheel services have shown them to offer system benefits such as reducing carbon dioxide emissions and avoiding the cycling of large fossil power systems. Beacon Power is currently developing and demonstrating megawatt-scale flywheel plants with cumulative capacities of 20 MW to support the frequency regulation market needs of ISOs (Figure 4-16).



**Figure 4-16**  
**1-MW/15-min Beacon Power flywheel in an ISO ancillary service application**

### **Lithium-Ion (Li-ion)**

Rechargeable Li-ion batteries are commonly found in consumer electronic products, which make up most of the worldwide production volume of 10 to 12 GWh per year. Already commercial and mature for consumer electronic applications, Li-ion is being positioned to be the leading technology platform for plug-in hybrid electric vehicle (PHEV) and all-electric vehicles (EV), which will use larger-format cells and packs with capacities of 15 to 20 kW-h for PHEVs and up to 50 kW-h for all-electric vehicles.

**Table 4-11  
Technology Dashboard: Lithium-Ion Battery Systems**

<b>Technology Development Status</b>	Demonstration C	Concept verified in limited field demonstrations.
<b>Confidence of Cost Estimate</b>	C	Vendor quotes and system installation estimates.
<b>Accuracy Range</b>	C-D	-10% to +20%
<b>Operating Field Units</b>	16 MW in frequency regulation application	Numerous small demonstrations in the 5-kW to 25-kW sizes are currently underway. MW-scale short-energy-duration systems are being operated in frequency regulation applications.
<b>Process Contingency</b>	10-15% Depends on chemistry	Battery management system, system integration, and cooling need to be addressed. Performance in cold climate zones needs to be verified.
<b>Project Contingency</b>	5-10%	Limited experience in grid-support applications, including systems with utility grid interface. Uncertain cycle life for frequency regulation applications.

Compared to the long history of lead-acid batteries, Li-ion technology is relatively new. There are many different Li-ion chemistries, each with specific power versus energy characteristics. Large-format prismatic cells are currently the subject of intense R&D, scale-up, and durability evaluation for near-term use in hybrid electric vehicles, but are still only available in very limited quantities as auto equipment manufacturers gear up production of plug-in hybrid electric vehicles (PHEVs) and electric vehicles (EVs). However, Li-ion battery OEMs are scaling up their global manufacturing capabilities to meet the future needs of the automotive market. The anticipated huge manufacturing scale of Li-ion batteries (estimated to total approximately 35 GWh by 2015) is expected to result in a supply over-capacity and lower-cost battery packs, which could be integrated into systems for grid-support applications requiring less than 4 hours of energy storage duration.

The high energy density and relatively low weight of Li-ion systems make them an attractive choice for areas with space constraints. Given their attractive cycle life and compactness, in addition to high ac-to-ac efficiency that exceeds 85%–90%, Li-ion batteries are also being seriously considered for several utility grid-support applications such as DESS (community energy storage), transportable systems for grid-support, commercial end-user energy management, home back-up energy management systems, frequency regulation, and wind and photovoltaic smoothing. Both electric utilities and Li-ion vendors are interested in selecting one or two high value grid-support applications that offer a combination of large market size and high value to accelerate the volume production of PHEV batteries. Many experts believe stationary markets for Li-ion batteries could exceed those for transportation.

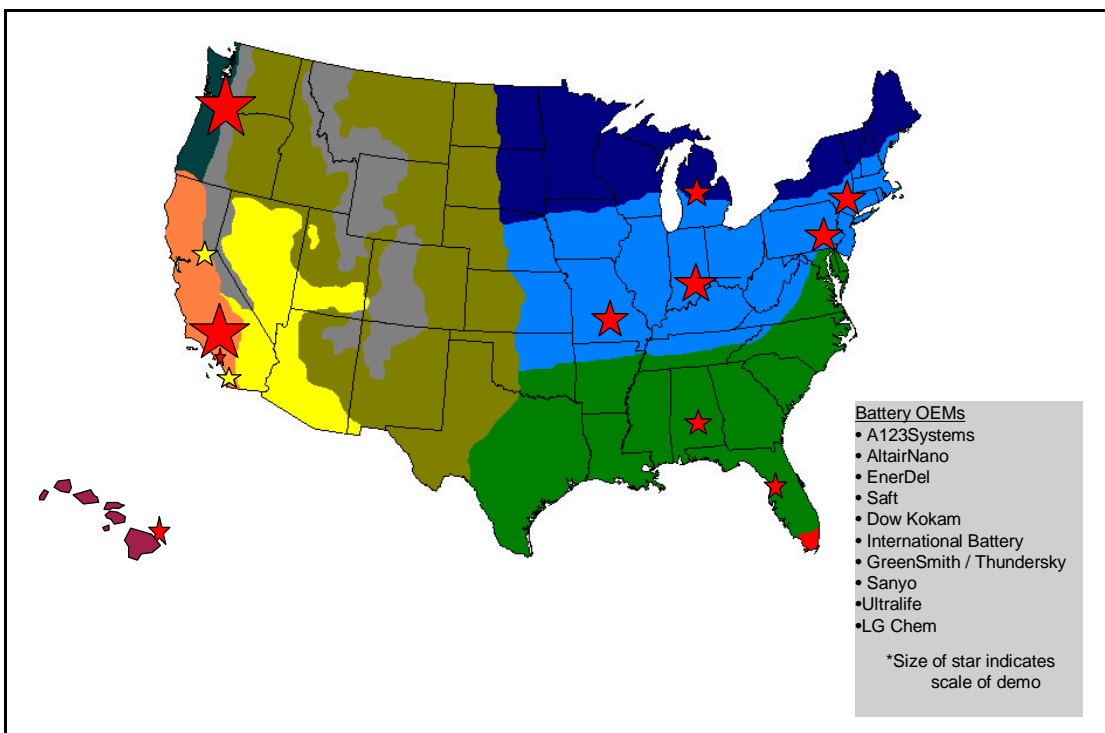

**Figure 4-17**  
**Locations of current and planned U.S. Li-ion system grid demonstrations. The stars represent the most significant projects; several other Li-ion projects are underway elsewhere.**

Early system trial applications are underway using small 5- to 10-kW/20-kWh distributed systems and large 1-MW/15-minute fast-responding systems for frequency regulation. Several electric utilities are also planning to deploy DESS systems in the 25- to 50-kW size range. In addition, Li-ion developer Altair Nanotechnologies has 1-MW/250-kWh trailer-mounted Li-ion battery systems in service with both AES and PJM, while A123 Systems has a 2-MW unit serving the California ISO and another 12 MW installed by AES Gener at a substation in Chile. In total, approximately 18 MW of grid-connected



advanced Li-ion battery systems have been deployed for demonstration and commercial service.



**Figure 4-18**  
1-MW/250-kWh transportable Altairnano Li-ion energy storage system at PJM



**Figure 4-19**  
Commercial operation of a 12-MW frequency regulation and spinning reserve project at AES Gener's Los Andes substation in the Atacama Desert, Chile. The system uses A123 Systems' Li-ion Hybrid Ancillary Power Units (Hybrid-APUs™).



**Figure 4-20**  
6-kW/20-kWh Li-ion system with inverter and controls by GreenSmith Energy Management. EPRI will be testing a 25-kW/50-kWh GreenSmith system in late 2010.



**Figure 4-21**  
A 50-kWh BYD Li-ion Battery System Planned to be Tested at EPRI's Knoxville, Tennessee Smart Grid Laboratory in 2011.

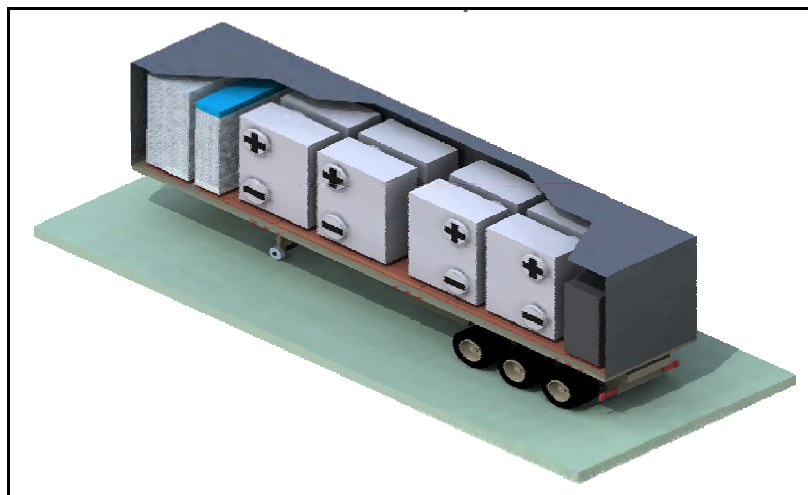

**Figure 4-22**  
EPRI's conceptual design of a 1-MW/2-MWh transportable energy storage system using Li-ion EV battery packs integrated for grid-storage solutions. EPRI plans to demonstrate this system by 2012.

## Representative Cost and Performance

A key objective of this chapter is to provide updated capital cost and performance data for each energy storage technology option by application.

Cost and performance estimates are “averaged” for representative energy storage systems in a specific application and use case, and have been normalized where possible to produce a consistent database. Estimates are not intended to apply to particular energy storage company at particular sites, since company-specific and site-specific applications can vary substantially. The data in this report does incorporate cost increases over the last three years due to more accurate estimates for near-term scope of supply and to heightened worldwide interest in electric energy storage. Earlier estimates by EPRI reflected projected trends based on volume production assumptions. Capital cost estimates are reported in December 2010 dollars.

In developing these estimates, an effort was made to assess the probable capital expenditures associated with implementing and installing a commercial-scale technology project. For each application, estimates were developed for installation, interconnection and grid integration costs. Estimating cost involves both analysis and judgment; it relies heavily on current and past data as well as project and vendor execution plans, which are in turn based on a set of assumptions. Estimates represent ongoing technology monitoring efforts at EPRI, which are continuing in 2011. EPRI will also be collaborating with DOE in 2011 to continue to update these estimates and to publish an updated *DOE-EPRI Energy Storage Handbook*.

**Table 4-12  
Bulk Energy Storage Options to Support System and Large Renewable Integration**

Applications:							
<ul style="list-style-type: none"> <li>Wholesale Markets</li> <li>Wind Integration</li> <li>Ancillary Services</li> </ul>							
Technology Option	Maturity	Capacity (MWh)	Power (MW)	Duration (hrs)	% Efficiency (total cycles)	Total Cost (\$/kW)	Cost (\$/kW-h)
Pumped Hydro	Mature	1680-5300	280-530	6-10	80-82 (>13,000)	2500-4300	420-430
		5400-14,000	900-1400	6-10		1500-2700	250-270
CT-CAES (underground)	Demo	1440-3600	180	8	See note 1 (>13,000)	960	120
				20		1150	60
CAES (underground)	Commercial	1080	135	8	See note 1 (>13000)	1000	125
		2700		20		1250	60
Sodium-Sulfur	Commercial	300	50	6	75 (4500)	3100-3300	520-550
Advanced Lead-Acid	Commercial	200	50	4	85-90 (2200)	1700-1900	425-475
	Commercial	250	20-50	5	85-90 (4500)	4600-4900	920-980
	Demo	400	100	4	85-90 (4500)	2700	675
Vanadium Redox	Demo	250	50	5	65-75 (>10000)	3100-3700	620-740
Zn/Br Redox	Demo	250	50	5	60 (>10000)	1450-1750	290-350
Fe/Cr Redox	R&D	250	50	5	75 (>10000)	1800-1900	360-380
Zn/air Redox	R&D	250	50	5	75 (>10000)	1440-1700	290-340

**Notes and Assumptions:**

- All systems are modular and can be configured in both smaller and larger sizes not represented. Figures are estimated ranges for the total capital installed cost of “current” systems based on 2010 inputs from vendors and system integrators. Included are the costs of power electronics if applicable, and all costs for installation, step-up transformer, and grid interconnection to utility standards. Smart-grid communication and controls are also assumed to be included.
- For all options, process and project contingency costs are included depending on technical maturity of the system.
- Pumped hydro: Storage durations can exceed 10 hours. There is very limited new cost data on pumped hydro facilities. Costs vary significantly by site but values presented include project contingencies and substation and interconnection costs. New EPRI updates on pumped hydro costs will be available in 2011.

4. CAES systems: Sizes up to 400 MW to 2000 MW+ are possible, as are underground storage durations of 20 to 30 hours or longer. The incremental cost of an additional 1 hour of storage once the cavern has been developed is \$1-\$5/kW. Data shown is only for the power and storage duration shown. CAES plants may have heat rates near 3850 Btu/kWh; energy ratios can range from 0.68–0.75. Estimates include process and project contingency and costs for NO<sub>x</sub> (SCR) emission-control technology. A storage cavern with salt geology is assumed; costs for other geologies can vary significantly and are site specific. Costs for siting, permitting, environmental impact studies and geological assessments are not included. Future system costs may be lower once standard, pre-designed systems are available.
5. Advanced lead-acid batteries: Cost estimates are based on use of advanced industrial-grade batteries from a number of suppliers. Battery life-cycle costs can vary considerably by supplier depending on the design basis duty cycle and design life. Battery replacement costs, while not shown, need to be considered as a variable O&M expense in any life-cycle analysis. Capital costs are reported on a “rated” MWh delivered per cycle basis. Costs for 50-MW systems are based on development of conceptual designs (Ref. 20).
6. Flow batteries: Redox battery systems can be sized for a wide range of power and duration of energy storage. Technology options for large vanadium, Zn/Br, Fe/Cr and Zn/air redox have not yet been built for large grid-scale (>10 MW) applications. Estimates are based on conceptual engineering designs, vendor quotes, site layout and grid interconnection estimates performed by EPRI. Vanadium systems are technically more mature, while Fe/Cr and Zn/air options still in the lab and early R&D stage of development.
7. For all systems, future system costs may be lower than shown after early demonstrations are proven and validated, products become more standardized, and initial engineering costs have been removed.

**Table 4-13**  
**Energy Storage Options for Frequency Regulation and Renewable Integration**

<b>Applications:</b>							
<ul style="list-style-type: none"> <li>• Utility Frequency Regulation</li> <li>• Power Quality</li> <li>• Defer Capital Cost Deferral</li> </ul>							
<b>Technology Option</b>	<b>Maturity</b>	<b>Capacity (MWh)</b>	<b>Power (MW)</b>	<b>Duration (hrs)</b>	<b>% Efficiency (total cycles)</b>	<b>Total Cost (\$/kW)</b>	<b>Cost (\$/kW-h)</b>
<b>Flywheel</b>	Demo	5	20	0.25	85-87 (>100,000)	1950-2200	7800-8800
<b>Li-ion</b>	Demo	0.25-25	1-100	0.25-1	87-92 (>100,000)	1085-1550	4340-6200
<b>Advanced Lead-Acid</b>	Demo	0.25-50	1-100	0.25-1	75-90 (>100,000)	950-1590	2770-3800

**Notes and Assumptions:**

1. This application is only for ISO frequency reg-up / reg-down markets, and “fast responding” limited energy storage systems are shown. These systems may also be applicable for smoothing intermittency of wind and photovoltaic power generation as well as C&I power quality applications. All systems are modular and can be configured in both smaller and larger sizes not represented. Figures are estimated ranges for the total capital installed cost of “current” systems based on 2010 inputs from vendors and system integrators. Included are the costs of power electronics if applicable, and all costs for installation, step-up transformer, and grid interconnection to utility standards. Smart-grid communication and controls are also assumed to be included.
2. For all options, process and project contingency costs are included depending on technical maturity of the system.
3. Pumped hydro systems can also provided a variety of ancillary services.
4. CAES systems can also provide a variety of ancillary services.
5. Advanced lead-acid batteries: There are several advanced lead-acid technologies. Data shown represents an average of currently available systems. Each unique system will have its own cost structure, so actual selected system costs by application will vary. Battery life-cycle costs can vary considerably by supplier depending on the design basis duty cycle and design life. Battery replacement costs, while not shown, need to be considered as a variable O&M expense in any life-cycle analysis, especially in this application where there are thousands of cycles per year. Capital costs are reported on a “rated” MWh delivered per cycle basis.

6. While not shown on this table, flow battery systems could also provide certain ancillary services and perhaps fast-responding reg-up / reg-down services.
7. Li-ion battery systems are finding initial use in this application. There are several different types of Li-ion chemistries, each with their own cost and performance characteristics. Data shown is the average of currently available systems. Each chemistry will have its own cost structure, so actual selected system costs may vary. Durability and life-cycle cost data is unavailable at this time. Battery replacements over the book life must be considered in a life-cycle analysis.
8. Flywheel systems are finding initial use in this application. Durability and life-cycle cost data is unavailable at this time. Flywheel replacements over the book life must be considered in a life-cycle analysis.
9. For all systems, future system costs may be lower than shown after early demonstrations are proven and validated, products become more standardized, and initial engineering costs have been removed.

**Table 4-14  
Energy Storage for Utility T&D Grid Support Applications**

<b>Applications:</b>							
<ul style="list-style-type: none"> <li>• Utility T&amp;D Substation Grid Support</li> <li>• Peak Shaving; CapEx Deferral, Reliability</li> <li>• Dual Mode-Frequency Regulation/RTO Market Participation</li> </ul>							
Technology Option	Maturity	Capacity (MWh)	Power (MW)	Duration (hrs)	% Efficiency (total cycles)	Total Cost (\$/kW)	Cost (\$/kW-h)
CAES (aboveground)	Demo	250	50	5	See note 1 (>10,000)	1950-2150	390-430
Advanced Lead-Acid	Demo	3.2-48	1-12	3.2-4	75-90 (4500)	2000-4600	625-1150
Sodium-Sulfur	Commercial	7.2	1	7.2	75 (4500)	3200-4000	445-555
Zn/Br Flow	Demo	5-50	1-10	5	60-65 (>10,000)	1670-2015	340-1350
Vanadium Redox	Demo	4-40	1-10	4	65-70 (>10,000)	3000-3310	750-830
Fe/Cr Flow	R&D	4	1	4	75 (>10000)	1200-1600	300-400
Zn/air	R&D	5.4	1	5.4	75 (4500)	1750-1900	325-350
Li-ion	Demo	4-24	1-10	2-4	90-94 (4500)	1800-4100	900-1700

**Notes and Assumptions:**

1. All systems are modular and can be configured in both smaller and larger sizes not represented. Figures are estimated ranges for the total capital installed cost of

“current” systems based on 2010 inputs from vendors and system integrators. Included are the costs of power electronics if applicable, and all costs for installation, step-up transformer, and grid interconnection to utility standards. Smart-grid communication and controls are also assumed to be included.

2. For all options, process and project contingency costs are included depending on technical maturity of the system.
3. CAES systems: Aboveground storage systems have estimated heat rates in the 3950-4100 Btu/kWh range and energy ratios of 0.79–0.81. Smaller systems in the 5- to 15-MW scale are also being considered for demonstrations. Site-specific costs will vary. Designs are modular and could be configured in larger sizes. Future system costs may be lower once standard, pre-designed systems are available.
4. Sodium-sulfur battery systems are the most proven for use in T&D grid support applications.
5. Advanced lead-acid batteries: Cost estimates are based on use of advanced industrial-grade batteries from a number of suppliers. Battery life-cycle costs can vary considerably by supplier depending on the design basis duty cycle and design life. Battery replacement costs, while not shown, need to be considered as a variable O&M expense in any life-cycle analysis. Capital costs are reported on a “rated” MWh delivered per cycle basis (Ref. 20).
6. Flow batteries: Vanadium, Zn/Br, Fe/Cr and Zn/air redox have limited deployment in grid-support “use-case” applications at this time. Redox battery systems can be sized for a wide range of power and hours of energy storage. Estimates are based on conceptual engineering designs and vendor quotes (Ref. 20), and include site layout and grid interconnection estimates performed by EPRI. Vanadium systems are technically more mature, Zn/Br systems are in the early stages of demonstration, and Fe/Cr and Zn/air systems are still in the laboratory and early R&D stages of development.
7. Li-ion Batteries: There are several different types of Li-ion chemistries, each with their own cost and performance characteristics. Suppliers stated they could provide systems from 1-10 MWS for this application. Data shown is the average of currently available systems. Each chemistry has its own cost structure, so actual selected system costs may vary. Durability and life-cycle cost data is unavailable at this time. Battery replacements over the book life must be considered in a life-cycle analysis. Li-ion systems for grid-support use are anticipated to be demonstrated in 2011.
8. For all systems, future system costs may be lower than shown after early demonstrations are proven and validated, products become more standardized, and initial engineering costs have been removed.



**Table 4-15**  
**Energy Storage for Commercial and Industrial Energy Management Applications**

Applications							
<ul style="list-style-type: none"> <li>Commercial and Industrial Energy Management</li> <li>Power Quality; Energy Management; Reliability</li> </ul>							
Technology Option	Maturity	Capacity (MWh)	Power (MW)	Duration (hrs)	% Efficiency (total cycles)	Total Cost (\$/kW)	Cost (\$/kW-h)
Advanced Lead-Acid	Demo-Commercial	0.1-10	0.2-1	4-10	75-90 (4500)	2800-4600	700-460
Sodium-Sulfur	Commercial	7.2	1	7.2	75 (4500)	3200-4000	445-555
Zn/Br Flow	Demo	0.625	0.125	5	60-63 (>10000)	2420	485-440
		2.5	0.5	5		2200	
Vanadium Flow	Demo	0.6-4	0.2-1.2	3.5-3.3	65-70 (>10000)	4380-3020	1250-910
Li-ion	Demo	0.1-0.8	0.05-0.2	2-4	80-93 (4500)	3000-4400	950-1900

**Notes and Assumptions:**

1. This application is for customer-side-of-the meter energy management, power quality and reliability. Other application may include photovoltaic time shifting. Electric utilities may gain from distribution grid support and peak load management.
2. All systems are modular and can be configured in both smaller and larger sizes not represented. Figures are estimated ranges for the total capital installed cost of “current” systems based on 2010 inputs from vendors and system integrators. Included are the costs of power electronics if applicable, and all costs for installation, step-up transformer, and grid interconnection to utility standards. Smart-grid communication and controls are also assumed to be included.
3. For all options, process and project contingency costs are included depending on technical maturity of the system.
4. CAES systems: Aboveground storage systems, while not shown, could find use in industrial settings where siting is possible.
5. Advanced lead-acid batteries: There are gigawatt-hours of lead-acid battery systems in use for back-up and UPS applications in the C&I sector that are not reflected in this table. Cost estimates are based on use of advanced industrial-grade batteries from a number of suppliers. Battery life-cycle costs can vary considerably by supplier depending on the design basis duty cycle and design life. Battery replacement costs, while not shown, need to be considered as a variable O&M expense in any life-cycle analysis. Capital costs are reported on a “rated” MWh delivered per cycle basis (Ref. 20).

6. Flow batteries: Vanadium, Zn/Br, Fe/Cr and Zn/air redox have limited deployment in this “use-case” application. Redox battery systems can be sized for a wide range of power and hours of energy storage. Estimates are based on conceptual engineering designs and vendor quotes (Ref. 20), and include site layout and grid interconnection estimates performed by EPRI. Vanadium systems are technically more mature, Zn/Br systems are in the early stages of demonstration, and Fe/Cr and Zn/air system options, while not shown, could find use in this application when more fully developed.
7. Li-ion batteries: There are several different types of Li-ion chemistries, each with their own cost and performance characteristics. Data shown is the average of currently available systems. Each chemistry has its own cost structure, so actual selected system costs may vary. Durability and life-cycle cost data is unavailable at this time. Battery replacements over the book life must be considered in a life-cycle analysis. Li-ion systems are anticipated to be demonstrated for C&I energy management in 2011.
8. For systems co-installed with roof-top photovoltaic systems, significantly lower costs may be possible if the same inverter can be used and the installation and interconnection can be done with the photovoltaic system.
9. For all systems, future system costs may be lower than shown after early demonstrations are proven and validated, products become more standardized, and initial engineering costs have been removed.

**Table 4-16  
Distributed Energy Storage (DESS) near Pad-Mounted Transformers**

<b>Applications:</b>							
<ul style="list-style-type: none"> <li>• <b>Distributed Energy Storage at Pad-Mounted Transformer</b></li> <li>• <b>Distribution Deferral; Peak Shaving</b></li> <li>• <b>Reliability</b></li> <li>• <b>Dual-Mode Frequency Regulation</b></li> </ul>							
<b>Technology Option</b>	<b>Maturity</b>	<b>Capacity (kWh)</b>	<b>Power (kW)</b>	<b>Duration (hrs)</b>	<b>% Efficiency (total cycles)</b>	<b>Total Cost (\$/kW)</b>	<b>Cost (\$/kW-h)</b>
<b>Advanced Lead-Acid</b>	Demo-Commercial	100-250	25-50	2-5	85-90 (4500)	1600- 3725	400-950
<b>Zn/Br Flow</b>	Demo	100	50	2	60 (>10000)	1450-3900	725-1950
<b>Li-ion</b>	Demo	25-50	25-50	1-4	80-93 (5000)	2800-5600	950-3600

**Notes and Assumptions:**

1. This application is primarily for utility-side-of-the-meter grid-support applications at the end of the line, near pad-mounted transformers. These systems could also be located near end-use customers or on the customer side of the meter for energy

management, power quality and reliability. In those applications, electric utilities may gain from distribution grid support and peak load management.

2. All systems are modular and can be configured in both smaller and larger sizes not represented. Ideally, systems with 3 to 4 hours of energy duration may be of most value for grid peak management. Figures are estimated ranges for the total capital installed cost of “current” systems based on 2010 inputs from vendors and system integrators. Included are the costs of power electronics if applicable, and all costs for installation, step-up transformer, and grid interconnection to utility standards. Smart-grid communication and controls are also assumed to be included. Siting and permitting costs are not included. Installation costs are based on aboveground configurations.
3. For batteries, values are reported at rated conditions based on reported depth of discharge. Costs include both process and project contingency depending on technical maturity of the system.
4. Advanced lead-acid batteries: Cost estimates are based on use of advanced industrial-grade batteries from a number of suppliers. Battery life-cycle costs can vary considerably by supplier depending on the design basis duty cycle and design life. Battery replacement costs, while not shown, need to be considered as a variable O&M expense in any life-cycle analysis. Capital costs are reported on a “rated” kWh delivered per cycle basis (Ref. 20).
5. Flow batteries have limited deployment in this “use-case” application. Redox battery systems can be sized for a wide range of power and hours of energy storage. While only the Zn/Br option is shown, other redox chemistries may also find application in this setting but may require additional siting and permitting costs depending on technology. Estimates are based on engineering designs and vendor quotes (Ref. 20), and include site layout and grid interconnection estimates performed by EPRI.
6. Li-ion battery systems are being actively considered for this application by electric utilities. There are several different types of Li-ion chemistries, each with their own cost and performance characteristics. Data shown is the average of currently available systems. Each chemistry has its own cost structure, so actual selected system costs may vary. Durability and life-cycle cost data is unavailable at this time. Battery replacements over the book life must be considered in a life-cycle analysis. Numerous Li-ion systems are being tested and evaluated for this application in 2011.
7. First-of-a kind systems costs may be higher than shown. Future system costs may be lower than shown after early demonstrations are proven and validated, products become more standardized, and initial engineering costs have been removed.

**Table 4-17  
Energy Storage for Residential Energy Management Applications**

Applications:							
<ul style="list-style-type: none"> <li>Residential</li> <li>Home Energy Management, Back-up Power, Reliability</li> <li>Home Photovoltaic Time Shifting</li> </ul>							
Technology Option	Maturity	Capacity (kWh)	Power (kW)	Duration (hrs)	Efficiency % (total cycles)	Total Cost (\$/kW)	Cost (\$/kW-h)
Lead-Acid	Demo-Commercial	10	5	2	85-90 (1500-5000)	4520-5600	2260
		20		4			1400
Zn/Br Flow	Demo	9-30	3-15	2-4	60-64 (>5000)	2000-6300	785-1575
Li-ion	Demo	7-40	1-10	1-7	75-92 (5000)	1250-11,000	800-2250

**Notes and Assumptions:**

1. This application is for customer-side-of-the meter energy management, power quality and back-up power. Other uses may include photovoltaic time shifting. Electric utilities may gain from distribution grid support and peak load management
2. All systems are modular and can be configured in both smaller and larger sizes not represented. Figures are estimated ranges for the total capital installed cost of “current” systems based on 2010 inputs from vendors and system integrators. Included are the costs of power electronics if applicable, and all costs for installation and grid interconnection to utility standards. Smart-grid communication and controls are also assumed to be included.
3. For all options, process and project contingency costs are included depending on technical maturity of the system.
4. Advanced lead-acid batteries: Both commercial and emerging advanced lead-acid systems are available. Cost estimates are based on input from a number of suppliers. Battery life-cycle costs can vary considerably by supplier depending on the design basis duty cycle and design life. Battery replacement costs, while not shown, need to be considered as a variable O&M expense in any life-cycle analysis. Capital costs are reported on a “rated” kWh delivered per cycle basis (Ref. 20).
5. Flow Batteries: Vanadium, Zn/Br, Fe/Cr and Zn/air redox have limited deployment in this “use-case” application. Redox battery systems can be sized for a wide range of power and hours of energy storage. Estimates are based on conceptual engineering designs and vendor quotes (Ref. 20). Fe/Cr and Zn/air system options, while not shown, could find use in this application when more fully developed.

6. Li-ion batteries: There are several different types of Li-ion chemistries, each with their own cost and performance characteristics. Data shown is the average of currently available systems. Each chemistry has its own cost structure, so actual selected system costs may vary. Durability and life-cycle cost data is unavailable at this time. Battery replacements over the book life must be considered in a life-cycle analysis. Li-ion systems are anticipated to be demonstrated for residential energy management in 2011.
7. For systems co-installed with roof-top photovoltaic systems, significantly lower costs may be possible if the same inverter can be used and the installation and interconnection can be done with the photovoltaic system.
8. For all systems, future system costs may be lower than shown after early demonstrations are proven and validated, products become more standardized, and initial engineering costs have been removed.

## **Emerging Energy Storage Technologies**

There are many other types of energy storage technologies, both mature and still in the R&D phase, that are not discussed in this white paper. Nickel-cadmium and nickel metal hydride (NiMH) batteries are mature and suitable for niche applications. Innovation and R&D continues in many other emerging storage technology options. Stages of R&D and timelines for demonstration and field deployment are summarized in Table 4-18.

**Table 4-18  
R&D Timelines for Emerging Energy Storage Options**

<b>Storage Type</b>	<b>Status/Innovation</b>	<b>Estimated Deployment Timing</b>
<b>Na/NiCl</b>	Used in transportation bus systems, now moving to grid-storage use. Bench-scale module testing. Improved lower-cost Na-NiMx under R&D	2011–2012 early demonstration and field trials.
<b>Zinc-Air Rechargeable</b>	Laboratory and bench scale. Integrated system.	2011 dc module for test. 2012 target for early demo trial.
<b>Fe/Cr Flow</b>	Bench-scale testing. Low-cost storage.	2011 dc modules for test.
<b>Zn-Cl Flow</b>	Bench-scale testing. Low-cost storage.	Small 2011 dc modules for test.
<b>Liquid Air</b>	System studies. Low-cost bulk storage.	2011–2012 first demo.
<b>Non/Low-Fuel CAES</b>	System studies underway to optimize cycle and thermal storage system. Low fuel and Non-fuel CAES for bulk storage.	2015 pilot demonstration of 5-MW system
<b>Underground Pumped Hydro</b>	System studies. New concepts under development.	Under study.
<b>Nano-Supercapacitors</b>	Laboratory testing. High power and energy density; very low cost.	2012-2015.
<b>Advanced Flywheels</b>	System studies. Higher energy density.	Under development. 2012.
<b>H<sub>2</sub>/Br Flow</b>	Bench-scale testing. Low-cost storage.	2012-2013 pilot demo.
<b>Advanced Lead-Acid Battery</b>	Modules under test. Low cost; high cycle life.	2011-2012 early field trials.
<b>Novel Chemistries</b>	Bench-scale testing. Very low cost; long cycle life.	2011-2012 modules for test.
<b>Isothermal CAES</b>	Development and bench tests. Non-fuel CAES for distributed storage.	2011–2012 pilot system tests.
<b>Advanced Li-ion Li-Air and others</b>	Laboratory/basic science. Lower costs; high energy density.	2015-2020.
<b>Aqueous Electrolyte Sodium-Ion Hybrid Device</b>	Bench-top cell and modules tested. Low-cost, long-life testing under way.	2011 for demo units, 2012–2014 for commercial deployment.

# 5

## DISCUSSION AND CONCLUSIONS

### Gap Analysis

The energy storage system costs presented in Chapter 4 and summarized in Tables ES-4 and ES-5 reflect the near-term storage system costs and input assumptions that were considered when evaluating their fit within the applications addressed in the analysis. Costs and technology characteristics, including operating restrictions for each storage technology, were used to assess current “gaps” between cost and value. Estimates of installed capital cost for the energy storage systems expected to be available within the next 1 to 3 years were obtained from vendors, OEMs and system integrators, and include uncertainties in performance as well as durability and contingency as estimated by EPRI. While site-specific conditions and application specific requirements may cause actual costs to vary, a summary of the technology gap analysis is presented in Figure 5-1, with values expressed in terms of \$/kW-h of energy storage capacity. Such cost gaps will be updated by EPRI in the future as more clarity becomes available from solution providers.

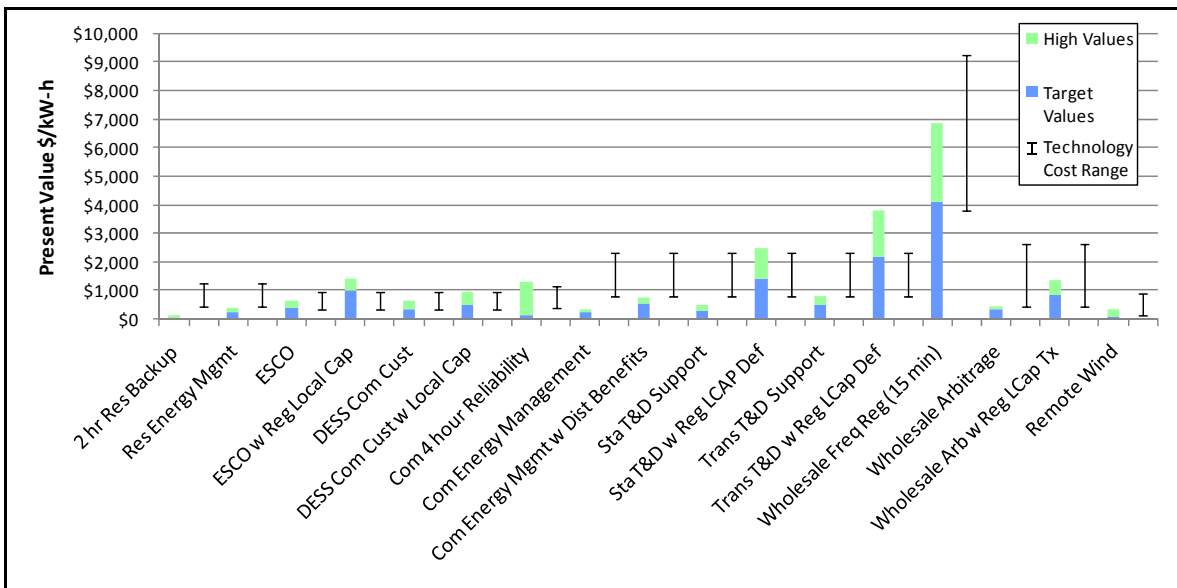

**Figure 5-1**  
**Application Value and System Cost Gap by Application for All Technologies**

When comparing storage technologies for a particular application, it is important to also examine levelized costs and benefits, since different technologies will have different expected useful lifetimes, efficiency, and discharge characteristics depending on the

application. In Figure 5-1, all technologies are compared over a 15-year lifetime, which is not to say that the expected lifetime of each storage technology is 15 years. Assumptions are made for each technology and then leveled based on the methodology presented in the Appendix. The figure examines each energy storage application compared to the range of technologies, and shows that some applications, such as residential backup power, appear currently uneconomical for all of the storage technologies examined. For other applications, such as transportable storage systems that can provide T&D support while also serving regulation and local capacity, the application values may exceed storage technology costs. For still other applications, such as commercial reliability, there may be economical storage applications only for customers that receive high benefit values, such as a commercial data center.

Figure 5-1 also suggests that there are currently certain storage applications that are economical for some of the technologies able to provide them.

EPRI research indicates that in the near term some storage technology costs will decrease significantly as the electric vehicle industry ramps up battery production. Also in the near term, underground compressed air energy storage (CAES) and pumped hydro systems are found to be lower in cost on a per kW-h basis, with the primary constraint being identifying developable sites, environmental permitting, and available near transmission assets.

In addition, advanced lead-acid batteries and Zn/Br flow batteries were generally found to have the potential for smallest gaps to support the energy storage business case for battery technologies. Emerging Fe/Cr and Zn/Air, while still in the laboratory and R&D stage, should be monitored as they may have a particularly low cost structure. Li-ion batteries, with the cost reductions anticipated via increasing global production capacity, could potentially prove competitive for a number of applications in the near and longer term for applications requiring less than 4 hours of energy storage.

Figure 5-2 illustrates gap analysis results from a technology perspective, giving a current snapshot of how the different technologies fare in serving the various applications defined in this report. The figure is not meant to illustrate which storage technologies will ultimately succeed in achieving market penetration in storage applications.



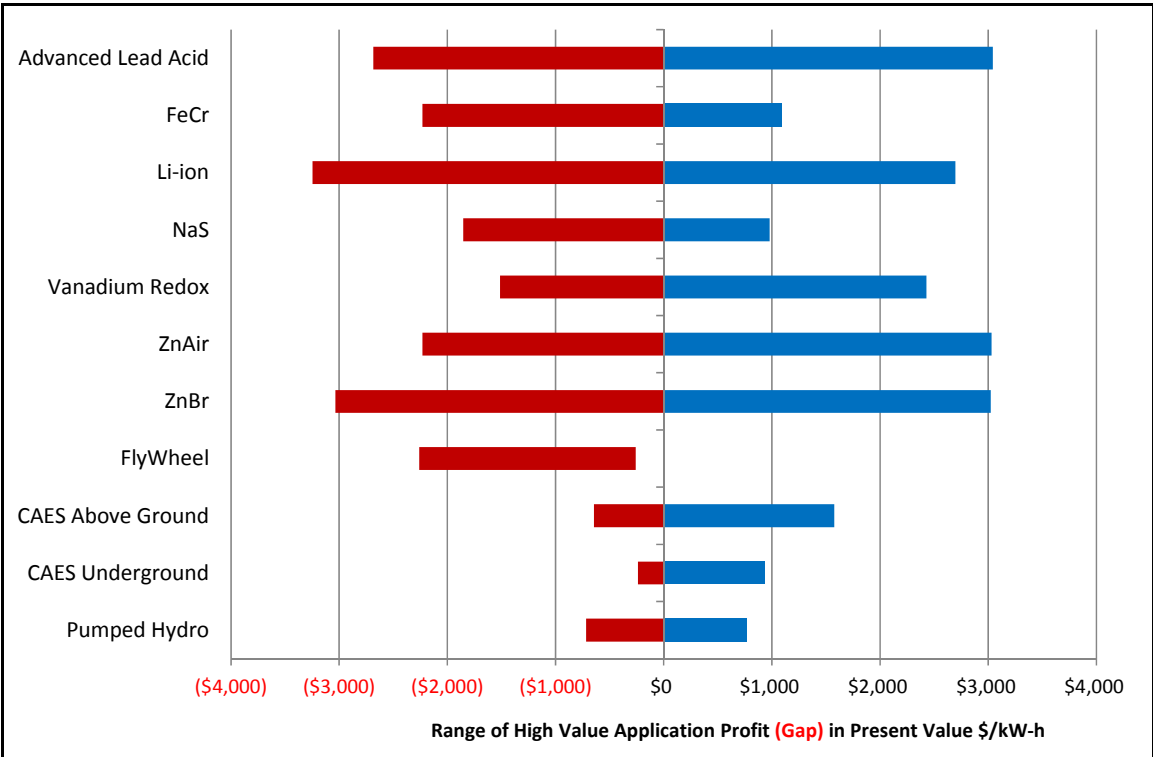

**Figure 5-2**  
**Gap Chart by Technology Including All Applications**

### Levelized Costs of Delivered Energy and Capacity

An alternative basis for comparing different energy technologies is to divide the total costs to construct, finance, operate and maintain a plant by its useful output. The costs are levelized using the cost of capital or discount rate to calculate a flat cost for energy (\$/kWh) and capacity (\$/kW-yr) over the life of the plant. Levelized cost of delivered energy or capacity provides a useful metric to compare the costs of technologies with different useful lives, efficiencies, and capacity factors on a fair basis.

For generation assets, the primary basis for comparison is the levelized cost of energy in \$/kWh. The cost or value of capacity is levelized on an annual basis and expressed as \$/kW-yr. Capacity cost represents the cost of a plant being available to provide electric generation whether or not it actually operates, analogous to an insurance premium. Although the primary purpose of a capacity asset is to provide energy when needed during peak demand periods or system outages, it can also earn revenue in energy and ancillary service markets throughout the year when it is economical to do so.

Therefore, when calculating the cost or value of capacity, the net revenues (or net margins) earned from other markets are first subtracted from the full cost of the plant.

This results in a residual capacity value. ISOs such as PJM, NYISO and CAISO calculate the residual capacity value of a combustion turbine to establish the “Cost of New Entry” (CONE). The CONE represents the additional payments needed over and above energy and ancillary service market revenues to provide sufficient incentive for a developer to construct and operate a new plant in the region.

Technologies designed primary for providing system capacity and reliability are generally assumed to provide only a limited amount of energy during peak load hours, hence the relatively low capacity factors. A CT has a lower efficiency/higher heat rate than a CCGT. A CT’s generation is therefore constrained to the limited number of peak hours during which higher energy prices allow the CT to recover its variable operating costs and make a profit. The economics for energy delivery from energy storage are constrained not by a fuel price and heat rate, but by the efficiency of the storage device and the on- to off-peak energy price differential. In all the markets analyzed for this report, this allows energy storage to operate at a higher capacity factor than a CT.

For example, Figure 5-3 shows the levelized cost of delivered energy (in \$/kWh) for energy storage technologies providing T&D Grid Support and Renewable Integration/Time Shifting using the low and high costs and efficiencies from Table ES-4.

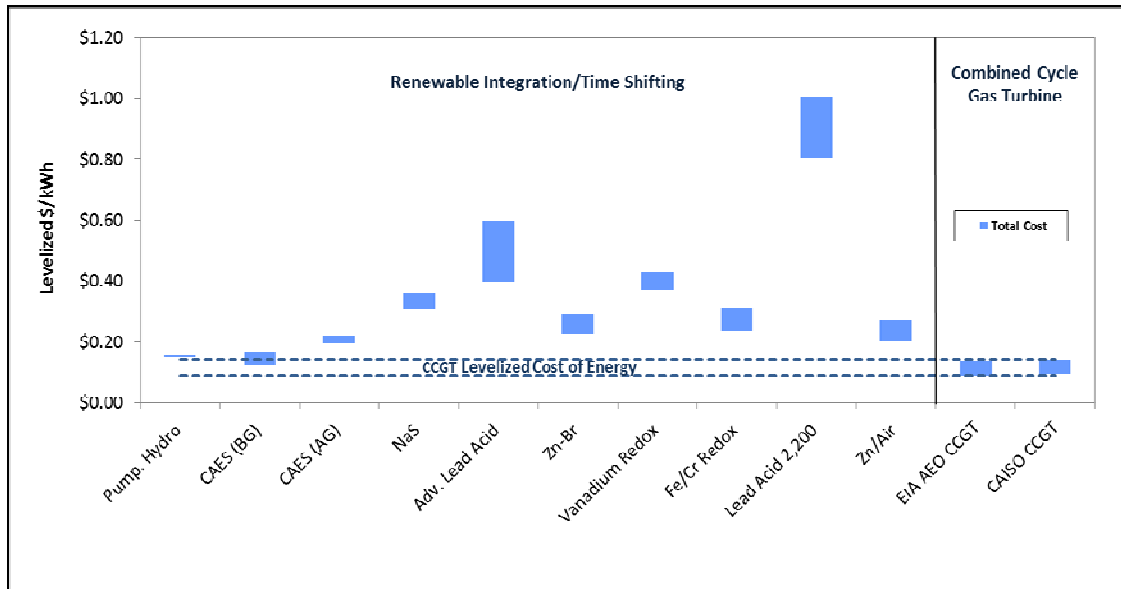
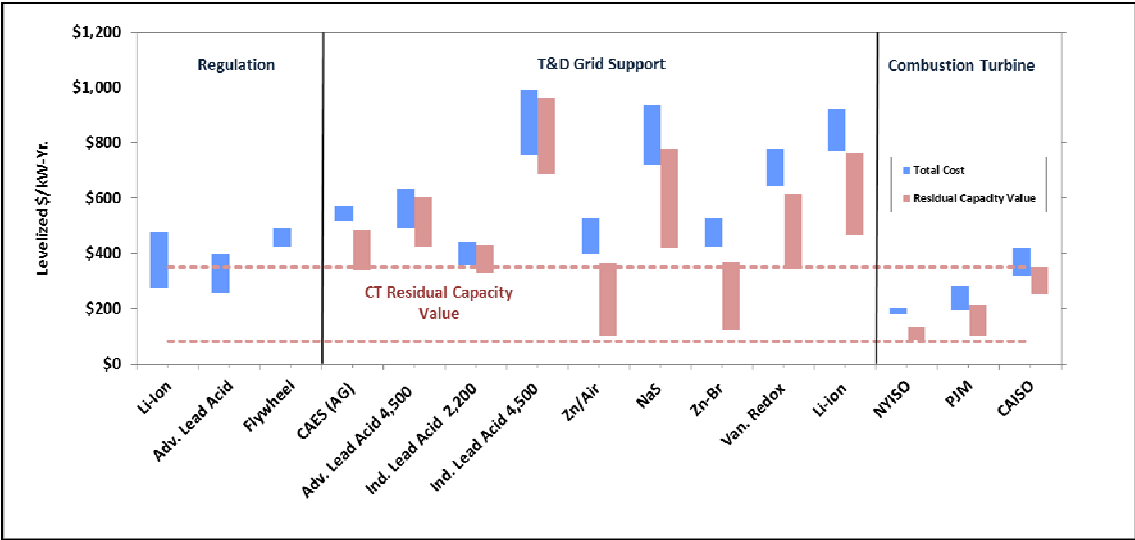

**Figure 5-3**  
**Levelized Cost of Delivered Energy for Energy Storage Technologies Compared to CCGT**

Annual O&M cost estimates are also included for both the low and high cost cases, but are highly uncertain given limited data and operational experience. These costs are then compared to the cost of energy generated by a CCGT. The energy storage costs are calculated assuming one full cycle per day (except for industrial lead-acid with 2,200 cycles) with an off-peak charging cost of \$30/MWh. Most technologies are compared

over a 20-year lifetime for the low-cost case and a 15-year lifetime for the high-cost case (See tables A-22 through A-25 in the Appendix). That is not to say that the expected lifetime of each storage technology is 15–20 years. Assumptions are made for each technology and then levelized based on the methodology presented in the full report.

Figure 5-4 shows the levelized total and residual capacity cost (in \$/kW-yr) for technologies providing Frequency Regulation and T&D Grid Support using the low and high costs and efficiencies from Table ES-4. These costs are compared to the total and residual capacity value for a combustion turbine calculated by PJM, NYISO and CAISO, respectively. Frequency Regulation assumes mileage of 0.18 kWh of energy per kW of regulation bid. The nature of the charge and discharge cycles required for frequency regulation is difficult to characterize accurately and not incorporated in this analysis. It is assumed that cycle life is not a limiting factor for this application, but that may not be true for all locations or technologies. T&D Grid Support assumes one full cycle per day (except for industrial lead-acid with 2,200 cycles).



**Figure 5-4**  
**Levelized Total and Residual Capacity Cost for Storage Technologies Compared to Combustion Turbine**

All applications assume a charging cost of \$30/MWh. For T&D Grid Support, as for a combustion turbine, a residual capacity value is calculated by subtracting potential energy and ancillary service revenues. All costs are levelized over the assumed useful life of the storage technology with an after-tax weighted-average cost of capital (WACC) of 10.46%. Additional assumptions include a levelized low and high natural gas cost of \$6.50 and \$8.00/MMBtu and a carbon price of \$30/ton. Tables with a complete list of assumptions used for each technology are shown starting in Table A-21 in the Appendix of the full report.

For T&D Grid Support, it is possible for the battery to serve its primary function of reducing grid loads during a small number of peak hours and earn revenues in the energy or ancillary service markets during other times of the year. Therefore, the net revenues that a T&D Grid Support storage system could earn in energy or ancillary service markets are subtracted from the total cost to calculate a residual capacity cost (in \$/kW-yr) that is comparable to the residual capacity cost of a CT. The regulation market, which is the most lucrative wholesale market for storage, is used to model net revenues for all the energy storage technologies except lead-acid, which is assumed to perform energy arbitrage only to maximize cycle life. Regulation revenues of \$300/kW-yr (approximately \$36/MWh) and \$160/kW-yr (approximately \$20/MWh) are used for the low and high cost cases respectively, based on storage dispatch modeling in NYISO and PJM. For lead-acid, energy arbitrage revenues of \$70/kW-yr and \$30/kW-yr are used for the low and high cost cases assuming 300 cycles per year for the 4500-cycle technology. The lead-acid 2200-cycle technology assumes 110 cycles per year, and energy revenues are reduced proportionally. T&D Grid Support assumes a minimum of one full cycle per day or 18% capacity factor for energy charging and discharging. All applications assume a charging cost of \$50/MWh.

The variable costs for CAES are modeled assuming a 3800 Btu/kWh heat rate and natural gas costs of \$6.50 and \$8.00/MMBtu for the low and high cost cases, respectively. For the residual capacity cost calculation, net revenues in the energy market are assumed to be \$70/kW-yr and \$30/kW-yr for lead-acid in the low and high cost cases. Regulation revenues are earned only for 4 hours of charge and discharge per day, providing \$106/kW-yr and \$87/kW-yr for the low and high cost cases.

## **Conclusions**

This paper presents recent key findings of EPRI's Energy Storage Research Program, which are intended to advance the understanding of the current near-term costs, value, and benefits of energy storage systems in various applications. Information, estimates, and data presented in this paper will be of value to utility system planners, strategic planners, and managers dealing with wind and photovoltaic integration, grid support investments, and smart grid programs. Results can form a foundation aiding the prioritizing of follow-on energy storage development and demonstration initiatives, as well as targeted energy storage solution projects.

The analysis summarized in this paper indicates that capturing multiple benefits, including transmission and distribution (T&D) deferral, local or system capacity, and frequency regulation, is key for high-value applications. Applications that achieve the highest revenues do so by aggregating several benefits across multiple categories.

When end-user reliability, distribution system support and system capacity benefits are aggregated in a T&D support application, the present value range of benefits is estimated to be less than \$500/kW-h of energy storage for the ISO markets modeled. For the same

application, if the energy system is able to provide regulation, is located in an area with local capacity requirements, and is able to defer transmission investments, our analysis estimates that the present value of benefits ranges from \$1228–\$2755/kW-h of energy storage. The number of locations at which all of these benefits can be realized together, however, is limited.

Based on EPRI's models, the highest value applications from a regional or Total Resource Cost (TRC) perspective are:

- Wholesale Services with Regulation
- Commercial and Industrial Power Quality and Reliability
- Stationary and Transportable Systems for Grid Support and T&D deferral.

Applications that provide high value to some end-use customers include:

- Commercial, Industrial, or Home Energy Management
- Commercial and Industrial Reliability and Power Quality.

The results imply that, based on the broader U.S. benefits of storage (target values), the total energy storage market opportunity is on the order of 14 GW if energy storage systems could be installed for about \$700/kW-h and the benefits estimated could all be monetized. Actual installed costs would need to be lower to accommodate life-cycle impacts and maintenance. Niche high-value markets could total nearly 6 GW if energy storage systems could be installed for \$1400/kW-h and all benefits could be monetized.

### ***Policy Implications***

Several policy challenges need to be resolved to realize the true potential of storage assets. Energy Storage systems have multi-functional characteristics, which complicates rules for ownership and operation among various stakeholders. Regulatory agencies have not defined ownership structures and flexible business models in which storage can be used for both generation and grid uses. Policy rules regarding allocation of costs incurred by adding storage systems to the grid need to be more clearly developed. Energy storage could enable bi-directional energy flows, creating potential problems for current tariff, billing and metering approaches. The results should help inform the development of new market structures and rules to accommodate and reap the benefits of emerging energy storage systems.

No single storage system can meet all of the application needs of the power grid, and a wide variety of storage technology options are being proposed for utility-scale storage uses and end-user energy management applications. EPRI research has identified leading energy storage candidates for near-term demonstrations: compressed air energy storage (CAES), which is currently the lowest cost (\$/ kW-h) bulk storage option for long

discharge (more than 10 hours) durations; and lithium-ion batteries, which could potentially be a cost-effective option in the long term for short durations (less than 4 hours). Certain flow batteries such as Zn/Br and vanadium redox, and emerging options such as Fe/Cr and Zn/air, show potential for low cost in the 4- to 8-hour or longer energy duration range. These systems should be tested, demonstrated and validated for grid applications. Costs for all of these systems are improving and rapidly changing, and should be updated annually.

In general, capacity applications utilizing short-duration energy storage devices appear to be the most favorable for energy storage market adoption. Short-duration storage benefit values include T&D support, local capacity, and the provision of ancillary services. While many technologies are able to target these short-duration applications, in the longer term Li-ion systems have the potential to be a cost-effective solution due to the massive scale of global production. Automakers are now employing Li-ion batteries to power their new generations of all-electric and plug-in hybrid electric (PHEV) vehicles. Li-ion batteries are attracting unprecedented amounts of research and development funding as well as enormous investments in production capacity. While future cost reductions are uncertain, Li-ion technology appears to have the most promising opportunity given its large annual gigawatt-hour scale of production. Economical Li-ion batteries could enable multiple cost-effective storage applications, particularly those of a shorter duration.

### ***Role for Electric Utilities***

Electric utilities are uniquely positioned to support energy storage applications because they can test, evaluate and deploy applications in different sections of the electricity value and supply chain, and ultimately monetize the benefits of the various applications. No single energy storage option meets every need for the applications identified. Instead, a portfolio of storage options that meet cost, performance and durability requirements will be needed to meet the needs of the electric enterprise. Utilities can use the results of this analysis to assess and value their application business cases. High-value markets identified can help focus future demonstration activities to advance the deployment and adoption of energy storage systems.

EPRI's analysis indicates that market or policy rules to accommodate new storage services could also have a significant impact on the allowable costs of energy storage systems. Key market definition issues for energy storage are minimum energy delivery requirements, energy-neutral dispatch, and premium values for fast and accurate response, minimum size, and aggregation rules. Research also identified several policy challenges that are limiting the true potential of energy storage:

- Energy storage systems' multi-functional characteristics complicate rules for ownership and operation among various stakeholders.

- Regulatory agencies have not defined ownership structures through which storage can be used for both generation and grid uses. In some jurisdictions, a grid asset may not participate in wholesale energy markets.
- Policy rules regarding allocation of costs incurred by adding storage systems to the grid need to be more clearly developed.
- Energy storage could enable bi-directional energy flows, creating problems for existing tariff, billing and metering approaches.
- New market structures and rules may be needed to accommodate and reap the benefits of emerging energy storage systems.





# 6

## RECOMMENDATIONS FOR FUTURE WORK

### Recommendations

Many of the energy storage options discussed in this report *have not been validated* in the applications discussed, and are not yet “grid-ready.” Figure 6-1 presents a near-term roadmap to achieve grid-ready storage solutions by 2015–2016.

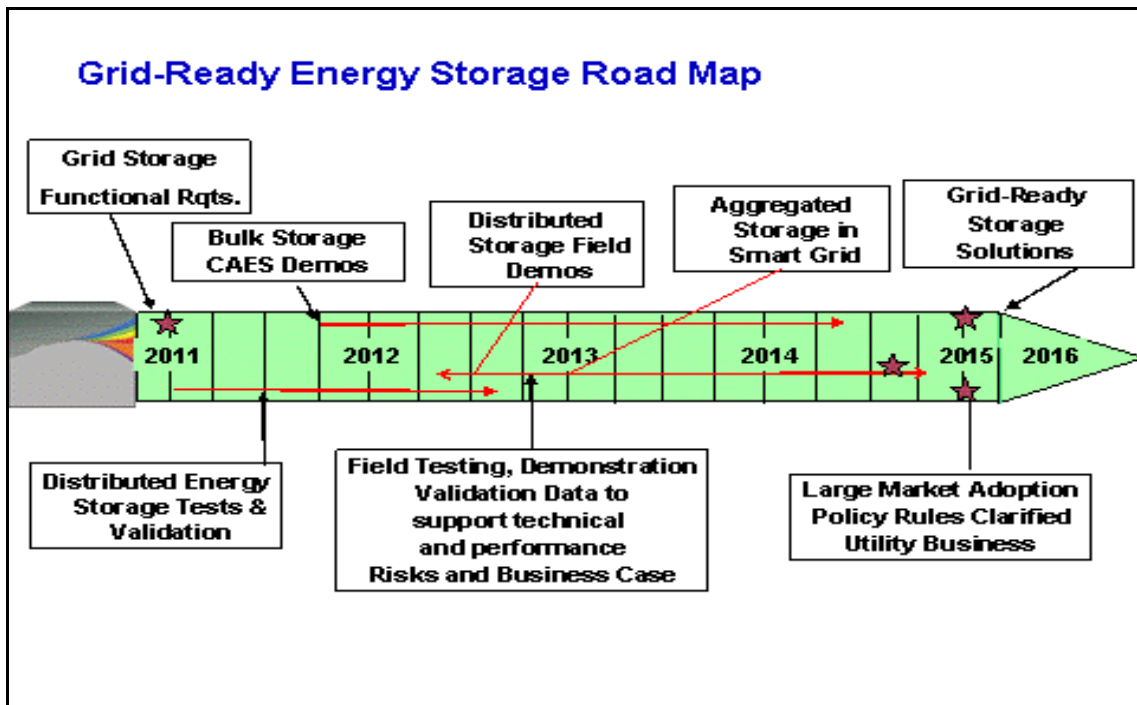

**Figure 6-1**  
Grid-Ready Energy Storage Roadmap

Table 6-1 is a suggested starting point intended to serve as a straw-man to begin that discussion. The table is not comprehensive—phases of development include much more, including fundamental research, analysis, testing, evaluation of risk, demonstration, and grid-ready validation—but is meant to offer a framework and direction for future work. Industry stakeholders should develop a blueprint action plan and roadmap for advancing the market integration of energy storage solutions within the electric enterprise. EPRI’s goal is to enable and achieve grid-readiness of energy storage solutions by 2015.

**Table 6-1  
Phases of Energy Storage Market Development**

Issue	Action	2010-2012	2011-2015	2016-2020
Research to understand the role, functional requirements, and value of storage to enable more renewable generation	Conduct regional ISO storage and T&D integrated assessments.  Engage stakeholders including ISOs to define functional requirements for wind and photovoltaic	Production simulation and cost-benefit analysis for specific storage sites, incorporating regional RPS scenarios.  Perform detailed case studies with utilities based on planned storage demonstrations.	Bulk energy storage demonstrations.  Storage for renewables integration (wind and photovoltaic).	Energy storage system capabilities understood and verified for Wind and photovoltaic Integration; technical and cost risks addressed.
Define applications for urban and rural load pockets	Define key applications and solutions  -Substation grid support -Transportable systems -DESS -C&I energy mgt -Residential energy mgt.	Grid integration requirements -Interconnection -Smart Grid communication and control  Market research on requirements for DESS to meet both end-user and utility needs.	Application-driven energy storage demonstrations and field trials.  Market-driven deployment and demo of selected applications/ solutions.	Market-driven deployment in high value applications.  DESS capabilities understood and verified for key applications; technical and cost risks addressed.
Industry regional and smart grid demo & trials	Develop action plan for storage and smart grid.  Develop business case for storage in smart grid	Storage and smart grid demo trials.  Pursue high-value utility applications identified in this and future reports.	Test, validation, integration, and communication and control.  Demonstrate promising bulk storage options.  Accelerate grid-readiness of Li-ion systems which leverage the auto sector.  Quantify benefits of storage systems in smart grid.	Energy storage assets used and aggregated in smart grids.  Storage as part of utility distribution planning activities.
Long-term energy storage R&D to lower costs, improve performance and cycle life.	Basic materials science ARPA-E Technology innovation Private equity Utility/industry partnerships	Establish stretch technology cost and performance goals for storage in various applications .e.g. total installed cost of <\$400/kW-h with 15-year cycle life.	Continued funding for long-lead-time technology.	Demonstrated technology capability of advanced energy storage systems.
Market Transformation	Consider policies that encourage integration of storage systems under multiple business/ ownership models.	Scope approaches for aggregation of multiple value streams.  Pilot projects testing new tariffs for storage that consider peak load management.	Review operating history of on-line storage facilities and provide feedback to regulators as appropriate.	Win-win storage solutions for all stakeholders in the electric enterprise.

Working with its member utilities and industry stakeholders, EPRI will collaborate to advance the deployment and grid integration of energy storage solutions for key applications that offer high near-term value to the electric enterprise. These applications and actions include:

- Stationary storage systems for grid support and T&D deferral
- Transportable storage systems for grid support and T&D deferral
- Distributed energy storage systems for edge-of-grid applications
- Wholesale services with regulation (15 minute)
- Product definition and application of Li-ion-based systems (using electric vehicle (EV) and plug-in hybrid electric vehicle (PHEV) platforms), which should be targeted for distributed energy storage for grid support and asset management, as well as for improved integration of photovoltaic generation on the distribution grid.
- Develop a demonstration initiative to accelerate and enable grid-ready energy storage systems which utilize battery pack systems for PHEV and EV automobiles.

Specific follow-on actions EPRI and its members could take include:

- Based on study findings, pursue EPRI program activities to specify application functional requirements, test and evaluate candidate systems, and conduct field demonstrations with member utilities.
- Develop specific technical and functional specifications for the high-value applications identified.
- Obtain vendor feedback and capabilities via a “request for information” solicitation.
- Select candidate systems to test, evaluate and verify before utility deployment.
- Develop collaborative deployment initiatives with interested utilities to accelerate deployment of high-value energy storage solutions. This includes monitoring and expanding existing smart grid pilot programs utilizing energy storage systems.
- Continue to monitor and follow developments in advanced energy storage systems that were not considered in this study, but which offer the potential for significant improvements in capital costs and cycle life.

Additional research and analysis in the following areas should also be considered as follow-on efforts for EPRI’s Energy Storage Program:

- Conduct market-based regional analysis to understand the role, requirements and value of storage systems to enable increased renewable penetration onto the electric system.
- Analyze the communications systems, technical specifications and size configurations required for energy storage to successfully defer T&D investments.

---

*Recommendations for Future Work*

- Carry out analysis to facilitate bidding into capacity and regulation markets.
- Conduct utility-specific evaluations of the business case for distributed energy storage.
- Develop an approach for balancing customer and utility benefits with aggregated systems.
- Examine the contribution of energy storage to future renewables scenarios, particularly distributed photovoltaic and utility-scale solar power systems.
- Assess renewable smoothing, integration and load-shifting, and analyze how the market may change as more renewables come online to meet renewable portfolio standard (RPS) goals.
- Assess new regional applications of energy storage not covered in this study.
- Assess energy storage for ramp and fast regulation services.
- Assess future development of the ESCO model to simultaneously balance customer and utility system benefits.

# A

## APPENDIX: FRAMEWORK AND METHODOLOGY FOR VALUATION OF ENERGY STORAGE APPLICATIONS

---

### Introduction

Traditional methods used to evaluate distributed energy resources (DER) such as energy efficiency and distributed generation do not adequately capture the range of benefits potentially provided by energy storage. Energy storage systems differ from other DER in four key respects in that they:

- Do not have a standard operating profile or load shape that can be applied prospectively.
- Are “energy limited” resources with a narrower band of operation than distributed generation.
- Have path-dependent capabilities that depend to a great extent on the status of the device at the beginning of the hour.
- Can provide or participate in multiple markets and provide several benefits simultaneously. While many services are complementary, some benefits will necessarily limit or preclude others.

The goal of this section is to lay out a transparent framework, methodology, and open assumptions which electric utilities, external stakeholders, regulators, and policy analysts can use (and also modify based on their own situations) to quantify and estimate the value of energy storage systems in particular applications.

While the value and benefit analysis can be done from various stakeholder perspectives (customer, utility, society), the focus on this methodology is from the electric system and societal perspectives. The underlying principle behind this approach is that the estimated value of storage (by application) is a good first-cut estimate for the allowable investment cost of fully installed energy storage systems. This section details the input assumptions and methods used to estimate the range of benefits associated with energy storage and the approach developed to address these unique characteristics, and to account for both the interdependencies and relative values of different benefits.

The framework began by identifying and bundling multiple benefits for the specific application(s) being considered. These applications were designed both to cover the range of current and identified potential uses of energy storage, and to group together complementary benefits that could maximize potential revenues.

The economics and operating characteristics of each storage technology were used to identify those technologies suitable for each application. An Excel/Visual Basic model was developed and applied to model the operation of each applicable combination of storage technology and application to determine the potential revenue values. The model performs a sequential dispatch of the storage device over the course of a year and estimates the total revenue earned for each benefit provided.

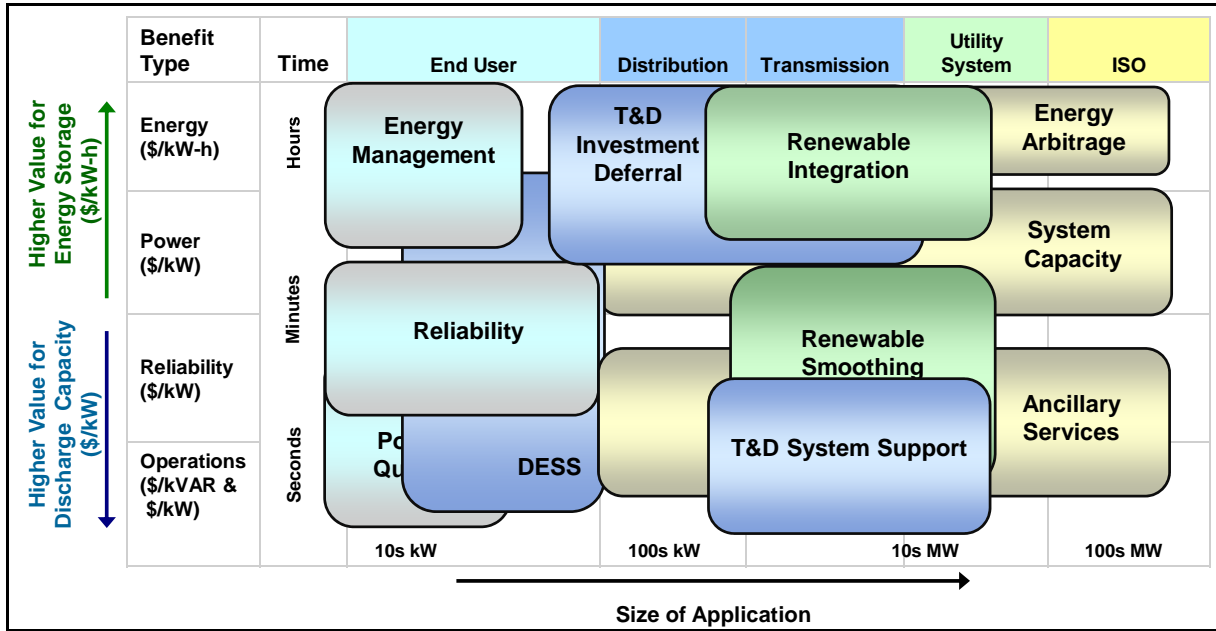

**Figure A-1**  
**Framework to Bundle Benefits by Application**

**Table A-1**  
**Inputs to Modeling Benefits**

		End User Applications	Utility Applications	System Applications
		Energy Management System	Capacity Investment Deferral (G, T, and D)	Wholesale Energy Markets
		<i>Business with existing energy management system, concerned about energy costs &amp; reliability</i>	<i>Provide T&amp;D capacity that can be deployed as needed</i>	<i>Market participant in ancillary and energy markets</i>
		Benefit Value Streams		
End User	1	Improve Power Quality	C	C
	2	Improve Power Reliability	C	C
	3	Reduce Retail Time of Use Energy Charges	C	
	4	Reduce Retail Demand Charges	C	
Distribution	5	Provide Voltage Support/Grid Stabilization	U	U
	6	Defer Distribution Investment	U	U
	7	Reduce Outage Frequency/Duration	U	
	8	Reduce Distribution Losses		U
Transmission	9	Reduce Congestion	U	U
	10	Relax Reliability Limits		
	11	Reduce Transmission Access Charges		
	12	Defer Transmission Investment	U	U
	13	Reduce Size of Renewable Energy Transmission		M
System	14	Defer Peak Capacity Investment	U	
	15	Provide System Capacity/Resource Adequacy	U	M
	16	Renewable Energy Integration (smoothing)		M
	17	Renewable Energy Integration (daily output shifting)		U
	18	Renewable Energy Integration (seasonal output shifting)		U
ISO Markets	19	Provide Regulation	U	M
	20	Provide Spin/Non-Spin/Replacement Reserves	U	M
	21	Provide Ramp		M
	22	Provide Black Start		M
	23	Provide Real Time Energy Balancing		M
	24	Energy Price Arbitrage		M

Hashed = Sensitivity

C = Customer

U - Utility

M = Market Participant

## End User Benefits

### Improved Power Quality

Power quality refers to the number of voltage sags and momentary outages experienced by a customer. In many instances, brief fluctuations in voltage may go unnoticed by the customer or may not interfere with normal equipment operations. When voltage sags are sufficiently large or sufficiently long, however, electronic equipment can experience problems or shut down. The

Technology Industry Council (ITI) publishes a Variation Curve that defines the voltage envelope that can typically be tolerated by most equipment with no interruption in function.

The impact of voltage sags and momentary outages to the vast majority of residential customers is minimal. However, certain types of commercial and industrial customers use equipment that can be sensitive to voltage sags and incur significant costs as a result of poor power quality. The most recent estimated values for power quality are from a 2009 study produced by Freeman, Sullivan & Co. (FSC) for Lawrence Berkeley National Laboratory (LBNL)<sup>19</sup>. The authors performed a meta-analysis of outage cost data from 28 surveys conducted by utilities measuring the value of electricity service to their customers. The meta-analysis found that momentary outage costs average \$0.10/kW for residential customers, with a range from \$0 at the 5th percentile to \$10.60/kW at the 95th percentile. Costs for small commercial and industrial (C&I) customers average \$120/kW with a range of \$0 to \$661/kW. The average value of service for large C&I customers is \$1.40/kW, ranging from \$0/kW at the low end to \$140/kW at the 95th percentile.

The \$120/kW momentary outage cost for small C&I customers stands out as much higher than that for large C&I customers. The small C&I momentary outage costs are also significantly higher than those found in other studies surveyed for this study<sup>20</sup>. According to the FSC study, this discrepancy is likely due to a small number of extremely high outage costs reported by survey respondents, which can skew the mean upward. Because the FSC results for the small C&I class deviated substantially from those for the large C&I class and other studies, we chose to use results from LaCommare & Eto 2004 for commercial customers instead (\$0.42/kW).

The ratios of the 95th percentile outage and the average outage cost of the FSC report were used to estimate a high value for power quality events. Across outage lengths from voltage sag to 4 hours, the ratio of the 95th percentile result ranges from 5.1 to 7.6 times high than the average. For small C&I and large C&I, the ratio of the 95th percentile to average for most outage lengths ranges from 5.1 to 8.5, and 9.7 to 25, respectively. For this study, the high outage cost values for the residential and small C&I was calculated by applying a ratio of 6.0 to average outage costs. For large C&I a ratio of 17 was used.

**Table A-2**  
**Momentary Outage Costs**

<b>\$/kW</b>	<b>Average</b>	<b>High</b>
Res	\$0.10	\$0.60
Small C&I	\$0.42	\$2.52
Large C&I	\$1.40	\$14.00

<sup>19</sup> Reference FSC2009

<sup>20</sup> Reference LaCommare & Eto 2004, Overdomain, LLC 2002, Woo 1992



## Improved Power Reliability

Energy storage can provide a source of backup power that allows customers to ride through a utility outage and continue normal operations. Smaller storage systems could be used to ride through an outage until conventional backup generation can start up or allow an orderly shutdown of equipment (approximately 1-10 minutes). Larger storage systems could themselves mitigate power outages for customers so long as the battery has sufficient storage to ride through the outage. This study focuses on managing outages of 4 hours or less. Given the current estimated costs of energy storage systems, we assume that conventional distributed generation would provide more cost-effective backup power for outages longer than 4 hours.

Outage costs from the 2004 LBNL report for the commercial class. The higher outage costs for commercial customers measured in terms of \$/kW is typical of all the studies reviewed. This is because commercial businesses are generally less energy intensive; while their total outage costs per event are generally lower than those for industrial customers, their \$/kW costs are generally found to be higher.

**Table A-3**  
**Average Outage Costs (2004 LBNL)**

\$/kW	15 Min.	30 Min.	1 Hour	2 Hours	4 Hours	8 Hours
Res	\$0.05	\$0.60	\$2.60	\$3.95	\$5.30	\$5.60
Small C&I	\$8.65	\$16.01	\$23.37	\$48.91	\$117.76	\$189.23
Large C&I	\$4.79	\$7.46	\$10.12	\$17.96	\$36.94	\$68.36

**Table A-4**  
**High Outage Costs**

\$/kW	15 Min.	30 Min.	1 Hour	2 Hours	4 Hours	8 Hours
Res	\$0.30	\$3.60	\$15.60	\$23.70	\$31.80	\$33.60
Small C&I	\$51.91	\$96.08	\$140.25	\$293.48	\$706.57	\$1,135.40
Large C&I	\$28.73	\$44.73	\$60.74	\$107.79	\$221.62	\$410.16

To quantify the reliability benefits of energy storage, it is necessary to estimate the number of outages of each length that a given customer would expect over the course of a year. The probability distribution of expected outages for this estimation was developed in three steps.

First outage metrics were taken from the 2004 LBNL study, which reported regional average System Average Interruption Frequency Index (SAIFI) and System Average Interruption Duration Index (SAIDI) statistics. SAIFI provides a measure of the number or frequency of outages, and is calculated as the total number of customer outages per year divided by the total

number of customers. SAIDI is a measure of the duration of those outages and is calculated as the total number of minutes customers went without power divided by the number of customers.

However, this analysis looks at outages not from the perspective of the utility, but of the individual customer. To that end, SAIFI and SAIDI were used to calculate a third metric, the Consumer Average Interruption Duration Index (CAIDI), which is the average number of minutes an individual customer would expect to go without power over the course of a year. CAIDI is calculated simply by dividing SAIFI by SAIDI. This division cancels out the total number of customers from the equation, leaving the average duration per outage per customer.

**Table A-5**  
**US Average and Regional Outage Statistics**

Region	CAIDI	SAIFI	SAIDI
US Average	88	1.2	106
Northeast	119	1.1	131
Southeast	115	1.0	115
North Central	79	0.8	63
South Central	73	1.3	95
Mountain	86	1.1	95
Northwest	88	1.2	105
Southwest	84	0.8	65
California	115	1.2	138

In the next step, the probability for each length of outage was estimated. The probabilities entered followed the form of a left-skewed distribution<sup>21</sup> (Figure A-2). The outage lengths given the highest probability are between 30 minutes and 2 hours. Outages of shorter durations have a lower probability while a long right-hand tail reflects increasing lower probabilities for outages of longer duration. We then entered a customer weighting to reflect the fact that a greater number of customers experience outages of shorter duration while a fewer customers experience outages of longer duration (8 hours or more).

The third step was to adjust both the outage probability and the customer weighting to yield a CAIDI similar to that for each region listed in Table A-5. The target values assume a number of outages based on the average SAIFI figures presented. The high values assume a SAIFI one standard deviation higher than the regional average.

<sup>21</sup> Attempts to use left-skewed probability distribution functions such as logarithmic or Weibull specifications did not yield satisfactory results; they tended to deviate significantly from empirical data either for the shorter outages of 30 minutes or less, or the longer outages of 8 hours or more.

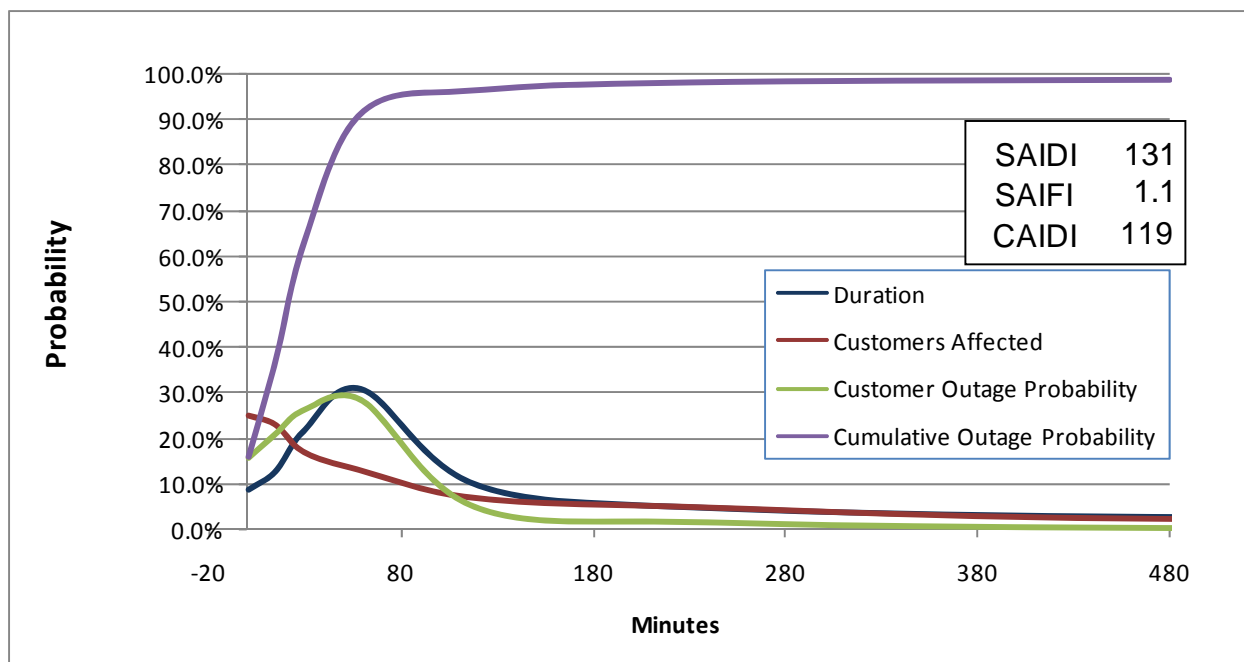

**Figure A-2**  
**Example Probability Distribution for Outage by Duration: Northeast Region**

### **Reduce Retail TOU Energy Charges**

One of the ways energy storage can reduce a customer's cost of electricity is by shifting energy purchases from on-peak periods with higher time-of-use (TOU) energy charges to off-peak periods with lower TOU charges. To value this benefit, we first determined which states had the highest average retail electricity rates in order to look for high TOU differentials. We selected the top quartile of states ranked by average commercial electricity rates (see Table A-5)<sup>22</sup>. We then selected a sample of TOU tariffs from utilities in each of those states for each customer class. For residential customers, the on-peak to off-peak price differentials in the tariffs surveyed range from \$0.06 to \$0.38/kWh. The differential for commercial customers ranges from \$0.05 to \$0.18/kWh. For industrial rates, the differentials range from a low of \$0.04/kWh to a high of \$0.13/kWh. The average and high TOU rates used in this analysis are listed in Tables A-6 to A-8.

It is absolute on-peak and off-peak rates, not just the differential, that affect the net cost savings provided by energy storage. This is because of the round trip efficiency loss incurred in charging and discharging energy storage systems. With efficiency losses of 20%, the battery must buy an additional 20% during the off-peak period. Consider two customers both with the same on-peak to off-peak differential of \$0.10/kWh, but one customer pays an off-peak rate of \$0.10/kWh while the other pays \$0.05/kWh. The efficiency penalty for the customer at the higher rate will be \$0.02/kWh (20% x \$0.10/kWh) as compared to a penalty of \$0.01/kWh for the customer paying the lower off-peak rate. For batteries with lower round trip efficiencies, the charging cost

<sup>22</sup> EIA "Electric Power Monthly" [http://www.eia.doe.gov/cneaf/electricity/epm/table5\\_6\\_b.html](http://www.eia.doe.gov/cneaf/electricity/epm/table5_6_b.html) (Sept. 2009)

penalty incurring paying retail rates at a customer’s premise can be particularly steep. For this reason, many technology providers are seeking tariff changes that will allow them to pay wholesale rather than retail rates for energy consumed in the provision of wholesale market services such as demand response or regulation.

**Table A-6  
Average TOU Rate Differentials**

State	Avg. Com. Retail Rate ¢/kWh
Hawaii	27.38
New York	15.41
Connecticut	15.34
Massachusetts	15.32
Rhode Island	14.96
New Hampshire	13.59
New Jersey	13.37
Alaska	12.9
Maine	12.75
Vermont	12.42
Maryland	11.8
California	11.66
Delaware	11.44

**Table A-7  
Average TOU Rate Differentials**

\$/kWh	Summer			Winter Rate		
	On-Peak	Off-Peak	Differential	On-Peak	Off-Peak	Differential
Res	\$0.25	\$0.06	\$0.18	\$0.13	\$0.06	\$0.07
Small C&I	\$0.18	\$0.05	\$0.13	\$0.12	\$0.05	\$0.06
Large C&I	\$0.06	\$0.04	\$0.02	\$0.05	\$0.04	\$0.01

**Table A-8**  
**High TOU Rate Differentials**

\$/kWh	Summer			Winter Rate		
	On-Peak	Off-Peak	Differential	On-Peak	Off-Peak	Differential
Res	\$0.39	\$0.16	\$0.22	\$0.24	\$0.16	\$0.08
Small C&I	\$0.21	\$0.09	\$0.12	\$0.16	\$0.09	\$0.07
Large C&I	\$0.13	\$0.09	\$0.04	\$0.09	\$0.07	\$0.02

In applications where distributed generation could serve the same purpose, an alternate value for the energy storage would be the avoided cost of the distributed generation system.

### ***Reduce Retail Demand Charges***

It is common for commercial and industrial customers to pay a monthly demand charge based on the customer's peak load measured over a defined period (i.e. the previous 12 months). Through strategic load shifting with energy storage, such a customer can reduce their demand charges in future bills by consistently reducing the customer's peak load as measured by the utility meter. The amount by which customer's measured peak load can be reduced is a function not only of the size of the battery, but also the customer's load shape. This application will prove most beneficial for customers with "peaky" load shapes—that is, with peak loads that occur over a relatively short period.

The same survey of retail rates performed for the TOU Energy Charge benefit showed C&I customer demand charges ranging from \$8 to \$23/kW-month. Demand charges for large C&I customers ranged from \$10 to \$20/kW-month. As expected, we did not find any residential rates that included demand charges. However, with increased deployment of AMI, it will become more feasible for utilities to consider demand charges for residential customers as well. The demand charges modeled for the average and high scenarios are shown in Tables A-9 and A-10.

**Table A-9**  
**Average Demand Charges**

\$/kW-Month	Summer		Winter Rate	
	On-Peak	Off-Peak	On-Peak	Off-Peak
Res	0	0	0	0
Small C&I	\$15.00	\$15.00	\$8.00	\$8.00
Large C&I	\$12.00	\$12.00	\$10.00	\$10.00

**Table A-10**  
**High Demand Charges**

\$/kW-Month	Summer		Winter Rate	
	On-Peak	Off-Peak	On-Peak	Off-Peak
Res	0	0	0	0
Small C&I	\$23.00	\$23.00	\$9.00	\$9.00
Large C&I	\$20.00	\$20.00	\$17.00	\$17.00

The amount of peak load reduction that can be achieved with energy storage is a function of the customer’s load shape. Consider two load shapes presented below (Figure A-3). Customer A has a relatively flat load shape compared to Customer B, whose load shape has a more pronounced peak. For each customer, we evaluate the load reduction that can be achieved with 45 kW-h of energy storage by shifting peak load to off-peak hours.

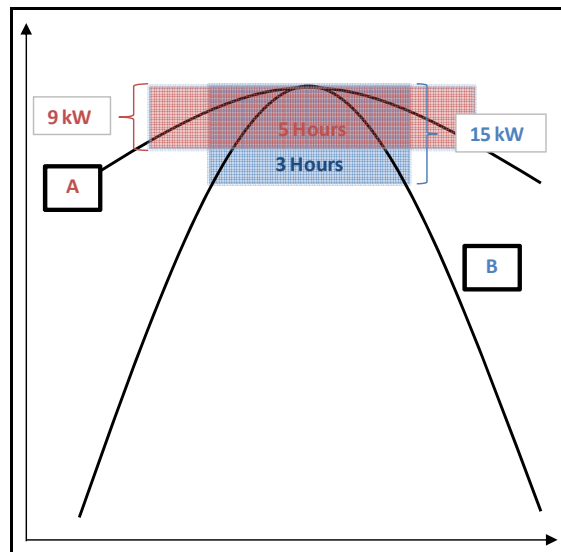

**Figure A-3**  
**Example Reduction in Peak Demand**

For Customer A with the flatter load shape, the 30 kW-h of energy storage can shift 5 peak hours of the customer’s load, reducing the peak by 9 kW. For Customer B, the same 30 kW-h of energy storage can shift only the top 3 hours of load, but results in a larger 15 kW reduction in peak load. This example illustrates the importance of the customer’s load shape in optimizing the discharge and energy storage capacity. In addition, notice that this example considers a battery that is optimally sized to achieve the maximum peak load reduction for a given quantity of energy storage (kW-h). Increasing either the discharge capacity (kW) *or* the energy storage capacity (kW-h) alone will increase the quantity of load that can be shifted, but will not lead to a greater reduction in peak load.

To estimate the potential benefit of demand charge reductions, we examined load shapes for customers and end-use loads. We selected a commercial cooling load shape with a pronounced peak and low load factor, similar to that of Customer B above, to estimate the maximum possible load reduction (Figure A-4). Using the load shape, we calculated the ratio of kW load reduction to kW-h of load shifted for the top 4 and 6 peak hours respectively. Shifting the top 4 hours (HE 13.5 to HE 17.5) requires 0.35 kW-h of energy storage and reduces the peak load by 0.15 kW. This results in a ratio of 0.43 kW in load reduction for every kW-h of energy storage, assuming the battery is optimally sized for this purpose. As the shift is extended further before and after the peak hour, each incremental kW-h of energy storage yields a smaller reduction in peak load, decreasing the kW to kW-h ratio. Shifting the top 6 hours (roughly HE 12 to HE 18), requires 1.1 kW-h of energy storage and reduces the peak load by 0.29 kW, a ratio of 0.28 kW peak load reduction for every kW-h of energy storage.

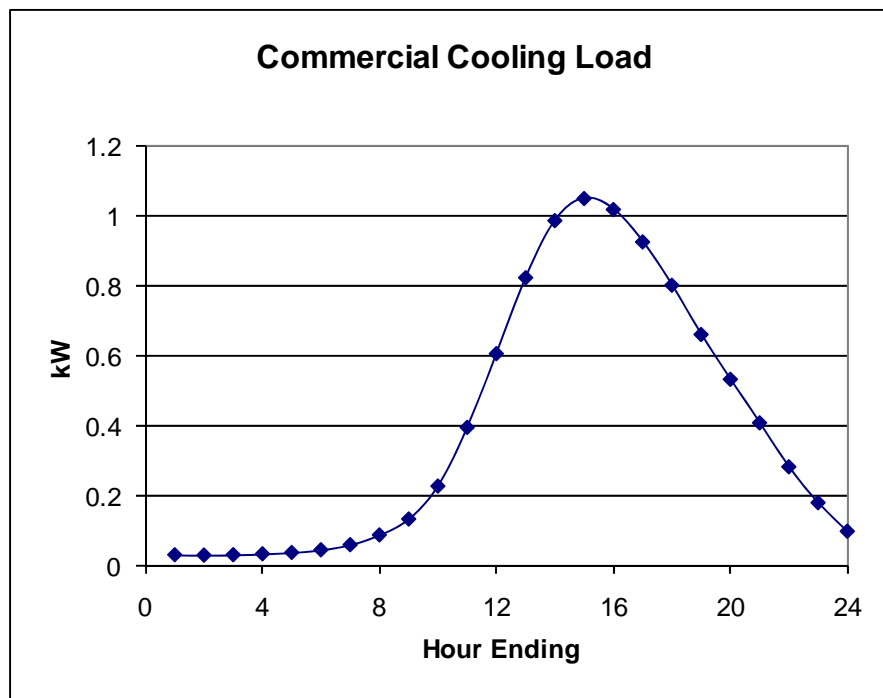

**Figure A-4**  
**Commercial Cooling Load Shape**

We use these ratios of 0.15 and 0.28 kW per kW-h of energy storage for the average and high demand charge reduction case, respectively. This is almost certainly on the high end for two reasons. The total load for most commercial and industrial customers will not have as pronounced a peak as is shown here for the commercial heating end use. Furthermore, it is unlikely that an energy storage system will be sized optimally for peak load reduction in most installations, as the battery will be performing multiple functions.

## Distribution System Benefits

### ***Provide Voltage Support***

Voltage sag occurs on the distribution system when loads exceed the ability the distribution system to deliver energy to that location. Voltage sag is of greatest concern during peak load hours and during hot afternoons when distribution lines and transformers are the most stressed. Energy storage can provide voltage support to the grid, reducing the probability of a voltage sag or outage. To determine the value of voltage support we use the price of a shunt capacitor, the most common technology currently providing voltage support. The range in the price of voltage support services provided by shunt capacitors is found to be between \$3/kVAR and \$8/kVAR based on a 2009 presentation by Arizona Public Service Co. and an academic paper by Sode-Yome and Mithulananthan (2004) of the Asian Institute of Technology. This analysis assumes that the capability of an energy storage device to deliver both real (kW) and reactive (kVAR) power is the same. It is not always clear in the cost specifications whether inverter and other balance of system costs include this capability however.

### ***Defer Distribution Investment***

A reduction in peak load growth allows distribution utilities to defer distribution system investments that are needed to accommodate anticipated load growth in a particular area. A detailed study of the distribution investment plans of four utilities across the United States was performed in 1994. The utilities were chosen for their geographic diversity in order to create a representative sample of utilities in the United States. The study reviewed the distribution upgrade investments planned for each region within a utility. Over a 10-year time horizon, the study took into account planned distribution investment costs to calculate the present worth of distribution deferral. The quantity of distribution deferral is measure in megawatts of deferred distribution investments, while avoided cost is measure is \$/kW-yr because the benefit of distribution deferral to the utility is spread out over the years for which the distribution is deferred.

Although the study is somewhat dated, it provides a detailed distribution of the diversity of costs for planned distribution investments among U.S. utilities. The study shows that in today's dollars, the avoided cost of distribution investment deferral ranges from \$390/kW-yr in a costly area to \$0/kW-yr in a distribution area with no need for distribution investment. For modeling purposes, the distribution of these avoided costs was examined to find target and high values of \$65/kW-yr and \$100/kW-yr for distribution deferral. These values represent 26% and 4% of possible distribution deferrals in a given year (see Figure A-5). Additional research is needed to quantify the operational value and CapEx deferral value of distributed assets like storage and distributed energy resources as part of a 20-year investment plan and smart grid strategy.

Alternative values could be calculated based on the competitive alternatives to energy storage for distribution investment deferral, which include distributed generation and energy efficiency measures.



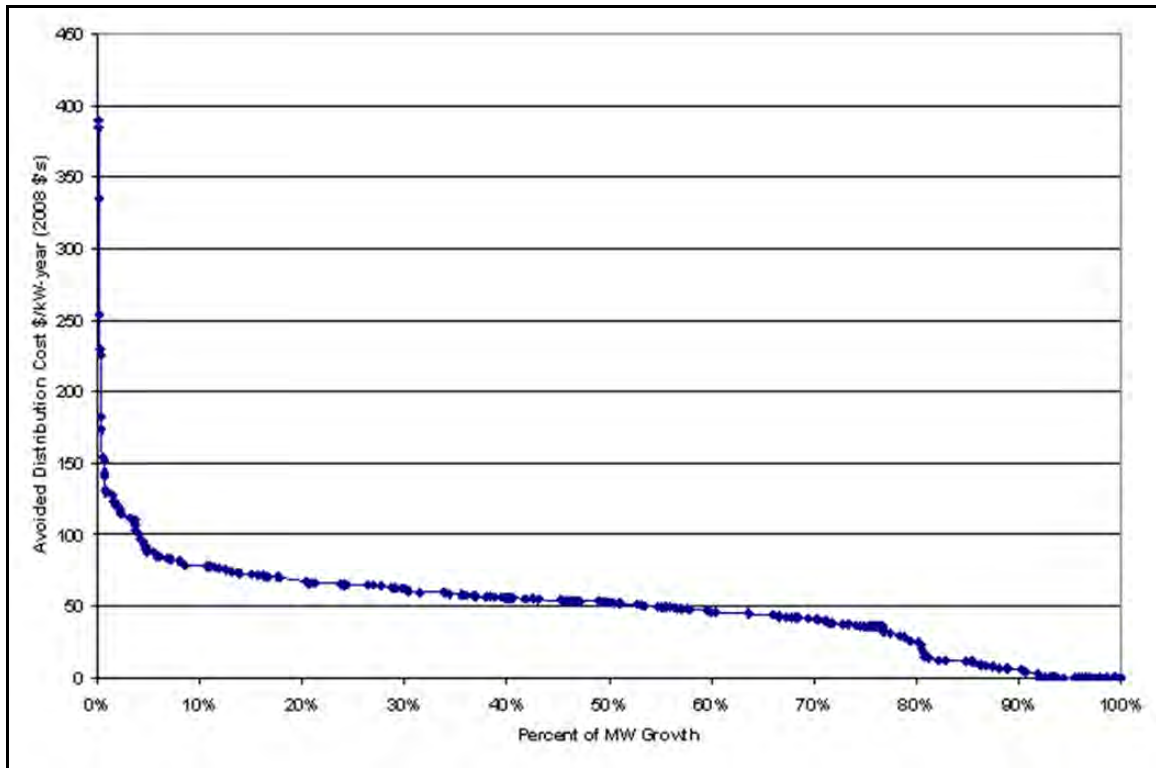

**Figure A-5**  
**Total Distribution Avoided Costs based on data from CP&L, KCPL, PG&E, and PSI**

### ***Reduce Distribution Losses***

Researchers have found that distribution losses typically range from 2% to 6%. Any energy storage system upstream of a congested distribution line could reduce losses on that line. On-peak distribution system losses of 4% and 6% are assumed for the average and high case. In each case, it was assumed that an energy storage system could reduce such losses by 30%.

## **Transmission System Benefits**

### ***VAR Support***

Voltage or reactive power support is used to maintain voltage levels on a transmission system by providing or absorbing reactive power (kVAR). Voltage support is used by ISOs to maintain grid stability and is procured through either contracts with generators (CAISO, ERCOT) or ISO tariffs (ISO-NE, NYISO, PJM).<sup>23</sup> In other countries, such as England, voltage support is procured via competitive procurement.<sup>24</sup> Currently, VAR support is supplied by generators, synchronous condensers, static VAR compensators, and inductor and capacitor banks. With a

<sup>23</sup> Isemonger, A.G., "The Competitive Procurement of Voltage Support" June 2006, California Independent System Operator, White Paper

<sup>24</sup> Ibid.

dynamic inverter and the necessary communications and control equipment, energy storage can also provide and absorb reactive power.

Three ISOs publish reactive power tariffs or payments, ranging from \$1.05/kVAR for ISO-NE to \$2.93/kVAR for NYISO and \$3.92/kVAR for PJM (See also Kueck, J. et al (2006)). The ISO-NE price of \$1.05/kVAR is used to represent the targeted cost, while the PJM price of \$3.92/kVAR is used for the high cost. This study assumed a storage device can provide kVAR up to its effective discharge capacity. In actual installations, additional costs for dynamic inverters and communications equipment may be required to provide this capability.

### ***Reduce Transmission Congestion***

Transmission congestion occurs when the physical limitations of transmission infrastructure prevent electricity transactions from occurring. When transmission congestion occurs, locational marginal prices at the point of generation and point of delivery diverge. In these cases, customers are forced to procure electricity from higher-priced local generation rather than from cheaper distant generation that requires transmission. Energy storage can relieve distribution congestion when sited correctly within the transmission network. Energy storage would be sited in the congested node such that it could shift the delivery of generation from on-peak to off-peak. This study applies two measures of the cost of transmission congestion to quantify the potential benefits provided by energy storage: energy arbitrage and firm transmission rights (a.k.a. financial transmission rights or congestion revenue rights).

One measure of the value of reducing congestion is the amount by which storage can reduce purchases at the high-priced node during hours when congestion is causing locational marginal prices (LMPs) to diverge. The number of hours over which congestion occurs varies widely, with some points recording over 3,500 hours of congestion per year and other points less than 300 hours per year.<sup>25</sup> If congestion does in fact occur only during on-peak periods, then LMPs at the high-priced node will converge with surrounding nodes during off-peak periods when no congestion is occurring. With this assumption, we use the value of energy arbitrage for LMPs at points downstream of transmission congestion. For ISONE, NYISO and PJM, such points were selected for this analysis.

A second metric is the value of a financial transmission right (FTR) contract, which is also determined by the difference between two set nodal prices. The FTR market product allows loads and generators to hedge against transmission congestion. The value of an FTR contract represents the market expectation of the difference in locational marginal prices of two nodes, a value that depends on congestion costs in day-ahead markets. An energy storage device could realize the value of this price differential if it were located in the congested node and could supply energy during the congested hours.

FTR contract clearing prices are publicly available from CAISO, ISO-NE, MISO, NYISO, and PJM.<sup>26</sup> In extremely congested areas such as New York City, FTR contracts can be very

---

<sup>25</sup> Open Access Technology International Inc., "Assessment of Historical Transmission Congestion in the Eastern Interconnection," July 2009, Department of Energy, version 1.2

<sup>26</sup> <http://www.caiso.com/1f64/1f647e2b6aaf0.html>

valuable, while in uncongested areas they are worth nothing. This study looks at the distribution of these contracts to determine targeted and high values for FTR contracts in each ISO (see table 5). In order to compare the contracts of the different ISOs, this study makes certain simplifying assumptions. All contracts are converted to 1 year contracts by dividing the price of the contract by the length of the contract over 1 year. For example, an FTR with a term of four years sold at auction for \$100 would be converted to a one-year contract worth \$25 ( $\$100/(4 \text{ years}/1 \text{ year})$ ). Likewise, a 6-month contract sold at auction for \$100 would be converted to a one-year contract worth \$200 ( $\$100/(0.5 \text{ years}/1 \text{ year})$ ). See Figure A-5 for the distribution of FTR contract prices within the ISOs surveyed.

One limitation to this study's methodology is that FTR market price data does not provide information on the number of congested hours from which the FTR contract derives its value. Therefore, it is necessary to use other data to make an assumption about the number of hours a congested line is actually congested. DOE issued a report in 2009 examining transmission system constraints in the Eastern Interconnection.<sup>27</sup> The DOE study explains that there are different ways to measure congestion and each provides a slightly different result. The three methods used in this study measure congestion based on locational marginal prices, path flow, and scheduled curtailments. The Eastern Interconnection study does not make conclusion regarding the "typical number" of congested hours. Based on the data presented, this study makes the assumption that for the targeted FTR contract, the transmission path covered by the target is congested 300 hours per year. For the high FTR contract, this study assumes the transmission path is congested 1,000 hours per year. The size of the storage device input into the model then determines how much value from transmission congestion that device could accrue. If the storage is large enough to discharge during all congested hours, it can accrue the full value of an FTR contract. If the storage cannot cover all congested hours, it accrues the prorated value of an FTR contract for the hours that it can cover.

The competitive alternatives to energy storage in the transmission congestion market are distributed generation and increased transmission infrastructure. The deferral of transmission infrastructure is another possible application of energy storage model in this report. For this reason, only one of the two values, "Reduce Transmission Congestion" or "Defer Transmission Investment", can be targeted by energy storage in a particular application.

---

[http://www.iso-ne.com/markets/othrmkts\\_data/ftr/auction\\_results/2008/aug/index.html](http://www.iso-ne.com/markets/othrmkts_data/ftr/auction_results/2008/aug/index.html)

[http://www.midwestmarket.org/publish/Folder/10b1ff\\_101f945f78e\\_-735b0a48324a?rev=1](http://www.midwestmarket.org/publish/Folder/10b1ff_101f945f78e_-735b0a48324a?rev=1)

<http://www.nyiso.com/public/products/tcc/auctions.jsp>

<http://www.pjm.com/markets-and-operations/ftr/auction-user-info.aspx#LongTermFTR0912>

<sup>27</sup> Open Access Technology International Inc., "Assessment of Historical Transmission Congestion in the Eastern Interconnection," July 2009, Department of Energy, version 1.2

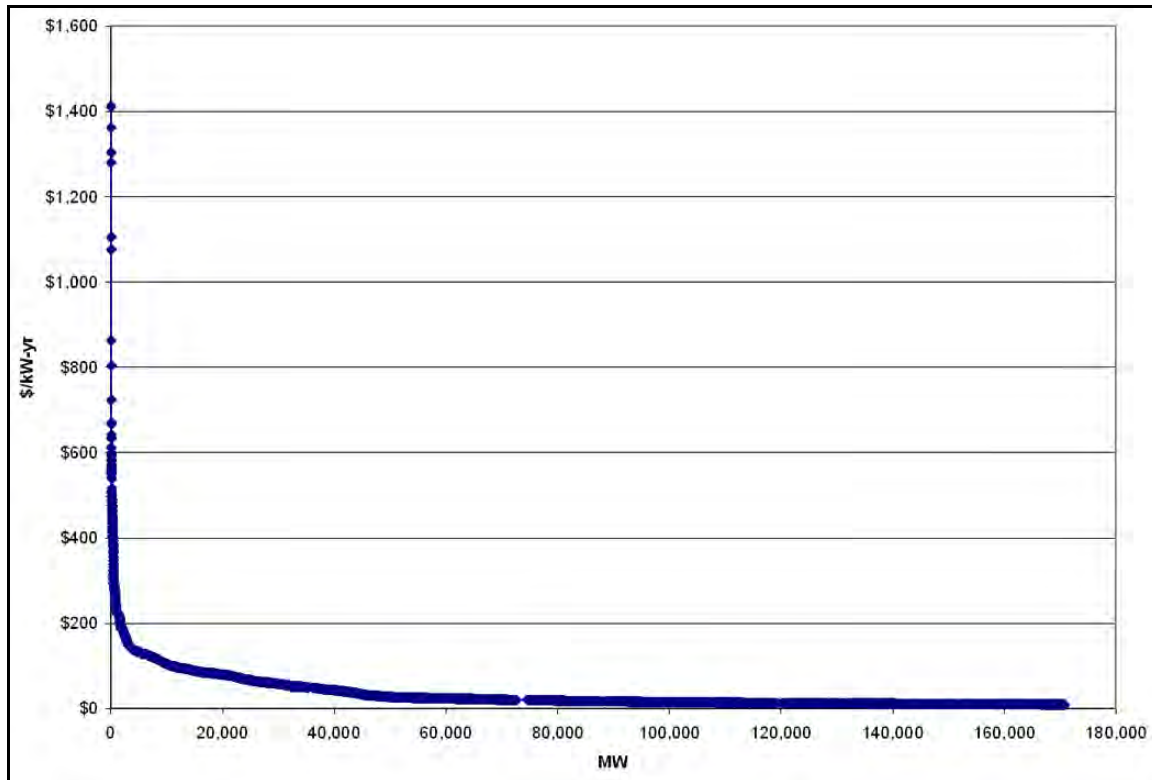

**Figure A-6**  
**2008 FTRs: PJM, NYISO, ISO-NE, CAISO, MISO**

Note: Due to size constraints, only the highest value contracts are shown on this graph. The contracts shown make up approximately 20% of the total market for FTRs by volume.

### ***Reduce Transmission Access Charges***

Transmission access charges are paid by transmission customers in return for transmission reservation. Transmission access is charged on a per-kilowatt basis. Energy storage can reduce the peak load demand of transmission customers and thereby reduce their transmission access charges. To measure the value of this savings, this study surveys Open Access Transmission Tariffs (OATTs) from a number of electric utilities in the United States. OATTs are made public on the OATI webOasis<sup>SM</sup> maintained by Open Access Technology International, Inc.<sup>28</sup> This study finds that an average transmission access charge is \$22.00/kW-yr, while a high transmission access charge is \$38.00/kW-yr.

### ***Defer Transmission Investment***

Transmission upgrade investments are necessary when transmission congestion limits the amount of electricity that can be sent through a pre-existing transmission line during peak hours.

<sup>28</sup> <http://www.oatioasis.com/>

By reducing peak load growth, energy storage could defer the transmission upgrade investments by a number of years. Energy storage would be sited in the congested node such that it could shift the delivery of generation from on-peak to off-peak, relieving congestion. In the model, we assume that in targeted cases the transmission investment could be deferred for three years while in high cases the transmission investment could be deferred for five years.

The cost of the investment being deferred is calculated using information from transmission access charges. Transmission owners are regulated utilities and their costs are passed on to customers in the form of transmission access charges. Therefore, the cost of a transmission investment on a per-kilowatt basis can be calculated by taking the PV of the transmission access charges over the life of the project (assumed to be 30 years). Given the PV costs of transmission investments one can calculate the value of an investment deferral. In the targeted case, the value of transmission investment deferral is \$208/kW-yr, and in the high case the value is \$354/kW-yr. Large (50 MW+ / 4–8 hr) energy storage systems may in practice be required to defer transmission investments but circumstances will vary based on site-specific needs.

## **System Benefits**

### ***Provide Local Capacity***

Some areas of the grid are not easily served by existing generation and capacity resources. These are typically urban load pockets with limited generation or transmission capacity and which face large or expensive infrastructure investments to increase that capacity. For example, in the NYISO Installed Capacity Market, clearing prices for capacity auctions are consistently higher for New York City than they are for the Long Island or Rest of System zones. ISOs also publish local capacity or reliability studies, usually on an annual basis, that identify zones or areas with minimum local generation capacity requirements to ensure reliable system operations. The ISO will then enter into contracts with or make payments to local generators to ensure their availability when needed.

Rather than selecting a target and high value, clearing prices for each ISO with a capacity auction are used to represent local and system capacity values in this study (Table A-11). For those ISOs with public capacity prices (ISONE, NYISO and PJM), the clearing prices for the highest priced zones are used for local capacity value. In each ISO, one year is selected for the target value and one year is chosen for the high value. The CAISO relies on bilateral contracts for local and system resource adequacy and does not currently have publicly available prices for capacity. ERCOT also relies on bilateral contracts with generators and does not have a capacity market. For CAISO, the local capacity value is based on the Cost of New Entry (CONE) for a combustion turbine, as calculated in the *CAISO Market Issues & Performance 2008 Annual Report* (CAISO 2009). For ERCOT, the U.S. Army Corp of Engineers Civil Works Construction Cost Index System (USACOE 2009) is used to adjust the CT capacity value from California to Texas (a reduction of 73%).

**Table A-11**  
**Local Capacity Value**

\$/kW-Yr	CAISO		ERCOT		ISONE		NYISO		PJM	
	Target	High	Target	High	Target	High	Target	High	Target	High
Local Capacity	\$101	\$101	\$73	\$73	\$168	\$168	\$57	\$109	\$69	\$80

### **System Capacity/Resource Adequacy**

As discussed in the previous section, ISONE, NYISO and PJM have each implemented a centralized capacity market. Though each market differs somewhat in its implementation, the general concept is similar. The ISO identifies the amount of generation capacity needed to meet anticipated peak load in a future year. The ISOs hold an auction from one to three years in advance soliciting offers from existing and new generators, and in some cases demand side options such as energy efficiency and demand response to provide that capacity. Because capacity markets inherently involve issues of market power, administrative bid caps or demand curves are generated to limit bid prices to a reasonable level. These demand curves are usually based on the CONE for a new combustion turbine in the range of \$90-\$160/kW-yr.

As above, the actual capacity auction prices from one of the years 2006-2008 is selected as the target capacity price and one as the high capacity price. While the highest price zones were used in for the local capacity price described above, the lower-priced or rest-of-system zones are used for system capacity (Table A-12).

As discussed above, both the CAISO and ERCOT rely on bilateral contracts and do not publish capacity values. Anecdotal discussions suggest prices in the \$30-\$40/kW-yr. are paid for system resource adequacy in California. A value of \$40/kW-yr is used for the system capacity value in both the CAISO and in ERCOT.

**Table A-12**  
**System Capacity**

\$/kW-Yr	CAISO		ERCOT		ISONE		NYISO		PJM	
	Target	High	Target	High	Target	High	Target	High	Target	High
System Capacity	\$40	\$40	\$40	\$40	\$50	\$81	\$27	\$29	\$15	\$41

### **Renewable Energy Integration**

As a number of states have adopted Renewable Portfolio Standards (RPS), utilities and ISOs have become increasingly interested in how renewable generation will be integrated with the existing generation portfolio and transmission grid. In particular, wind generation is expected to present a challenge to grid operators at increasing penetrations. Wind generation is difficult to

forecast accurately and peaks at night in many regions, when system loads are at their lowest. The issue of wind integration can be thought of in four distinct components (DeCesaro 2009, NREL 2009). The first is regulation, an ancillary service discussed in the next section, which is the management of second to second variations in system generation, load and frequency. The second is load following, which is matching generation to load as it ramps up and down over a period of hours in the morning and evening respectively. A third component is that of unit commitment or the need to start up fossil units in order to remain prepared to meet loads in the event of a sudden drop in renewable generation. The final component is that of net qualifying capacity (NQC) or how much system capacity renewable generation can be counted on to provide during peak hours versus how much must be procured from other dispatchable resources.

This framework does not attempt to model the individual components, instead modeling the total cost of renewable integration as a single value. Modeling the individual components of renewable integration is identified as a recommended next step in analyzing the value of energy storage. Based on that survey of recent renewable integration studies, \$3.13/MWh is modeled for the target value and \$9.59/MWh is modeled for the high value.

**Table A-13**  
**Renewable Integration**

\$/MWh	Target	High
Deferral Value	\$3.13	\$9.59
Years of Deferral	3	5

## ISO Market Benefits

### *Regulation*

Regulation is procured by ISOs to match extremely short-term fluctuations in system load, generation and frequency. Regulation is provided by generators that can respond quickly (usually within 4 seconds) under Automatic Generation Control (AGC) to dispatch orders issued by the ISO. Current regulation requirements were designed with traditional generation resources in mind, and require a minimum of 1 hour of energy delivery capability to participate in the market. This provides sufficient capacity to meet the short-term fluctuations and the increased ramp over each hour in the morning and corresponding decrease in hourly loads in the late evening.

All the ISOs included in this study have competitive regulation markets. As for the ISO system capacity markets, a single year for each ISO is selected to model the target and high value. The hourly regulation prices for the chosen year are used in modeling the dispatch of the storage system.

**Table A-14**  
Annual Average Regulation Values

\$/kW-Yr	CAISO		ERCOT		ISONE		NYISO		PJM	
	Target	High	Target	High	Target	High	Target	High	Target	High
Regulation	\$43.47	\$54.78	\$37.58	\$44.03	\$58.15	\$65.82	\$70.87	\$96.35	\$38.68	\$80.50

The typical dispatch signal issues by the respective ISOs to individual generators are not readily available. A preliminary analysis of a regulation signal provided by PJM to EPRI showed, on average, a positive energy bias of approximately 2% over the period studied. An energy storage device would be dispatched to provide regulation-up (provide energy) more often than regulation-down (reduce generation). The hourly dispatch model assumes that over the course of an hour, the amount of energy stored is reduced by 2% of the megawatts bid into the regulation market each hour.

### ***Fast Regulation***

Technology companies have argued that storage systems can respond much faster to regulation signals than traditional fossil and hydro generation, and that they therefore provide a greater value. As evidence they cite the Pacific Northwest National Laboratory Report *Assessing the Value of Regulation Resources Based on Their Time Response Characteristics* (PNNL 2008a). That study finds that a fast regulation device with limited energy is 1.17 times more efficient than the existing mix of resources providing regulation in the CAISO. Fast regulation is found to be 2.24 times more efficient than a CT. When modeling fast regulation, the hourly ISO regulation prices are multiplied by the factors listed in Table A-15.

**Table A-15**  
Fast Regulation

	Target	High
Efficiency Factor	1.17	2.24

### ***Spinning Reserves***

Spinning reserve is generation capacity that is already operating and synchronized to the system that can increase or decrease generation within 10 minutes. Some systems define both synchronous and non-synchronous spinning reserves. Spinning reserves are procured by the ISO on an hour-by-hour basis in a competitive market. Energy storage is capable of bidding in the spinning reserve market to supply reserves.

During most hours of the year, regulation prices are higher than spinning prices. Given the choice between bidding into the regulation or spinning reserve market, the owner of a storage device will most often bid into the regulation market. In some cases, however, spinning reserve



prices exceed regulation prices. To find the value of spinning reserves, we downloaded publicly available spinning reserve hourly market clearing prices from 2006 through 2009. This information is publicly available for CAISO<sup>29</sup> and ISO-NE.<sup>30</sup> In ERCOT, the ancillary service that we are calling spinning reserve is known as responsive reserve. Responsive reserve hourly market clearing prices are publicly available.<sup>31</sup>

In NYISO, the 10-minute ancillary service is known as 10-minute non-spinning reserve. NYISO also has a 30-minute non-spinning reserve product. Although both products are non-spinning, the 10-minute and 30-minute products are similar to spinning reserve and non-spinning reserve respectively in the other ISOs. Therefore, this study uses publicly available 10-minute non-spinning reserve price data from NYISO in place of spinning reserve.<sup>32</sup>

PJM does not have spinning reserve hourly market clearing prices available for this time period and was not included in this portion of the analysis.<sup>33</sup> We then take the hourly data to create a dispatch model with spinning reserve prices. In the ISOs, the price of spinning reserves in 2008 varied from \$399/MWh and \$0/MWh depending on the hour.

### ***Non-Spinning/Replacement Reserves***

Replacement reserve is capacity that is not operating, but can be up and running within 30 minutes to provide generation if needed. In some cases, replacement reserve is referred to as non-spinning reserves while in other cases they are differentiated products. In ERCOT this is known as non-spinning service.<sup>34</sup> In CAISO it is known as non-spinning reserve.<sup>35</sup> In NYISO this is known as 30 minute non-spinning service.<sup>36</sup> In PJM this is known as day-ahead scheduling reserve.<sup>37</sup> ISO-NE has 10-minute non-spinning reserve and 30-minute operating reserve in addition to their 10-minute spinning reserve product.<sup>38</sup> Both of these could be served by energy storage. In all the ISOs, the potential value from providing regulation and spinning reserve always exceeds the value for providing replacement reserve.

### ***Black Start***

Black start is the service of providing electricity to restart other generators during a power outage. Many power plants require electricity from the grid to perform start-up operations so generators that do not need to be electrically connected to the system help restore service after a blackout. The ISOs pay generators within their service area to provide this service. In some

<sup>29</sup> <http://oasishis.caiso.com/>

<sup>30</sup> [http://www.iso-ne.com/markets/hst\\_rpts/hstRpts.do?category=Hourly#anchor2](http://www.iso-ne.com/markets/hst_rpts/hstRpts.do?category=Hourly#anchor2)

<sup>31</sup> <http://www.ercot.com/mktinfo/prices/mcpc>

<sup>32</sup> [http://www.nyiso.com/public/market\\_data/pricing\\_data.jsp](http://www.nyiso.com/public/market_data/pricing_data.jsp)

<sup>33</sup> <http://www.pjm.com/markets-and-operations/ancillary-services/synchronized-service.aspx>

<sup>34</sup> <http://www.ercot.com/mktinfo/prices/mcpc>

<sup>35</sup> <http://www.caiso.com/2390/239087966e450.pdf>, section 4.1

<sup>36</sup> [http://www.nyiso.com/public/market\\_data/pricing\\_data.jsp](http://www.nyiso.com/public/market_data/pricing_data.jsp)

<sup>37</sup> [http://www.monitoringanalytics.com/reports/PJM\\_State\\_of\\_the\\_Market/2008/2008-som-pjm-volume1.pdf](http://www.monitoringanalytics.com/reports/PJM_State_of_the_Market/2008/2008-som-pjm-volume1.pdf), page 45

<sup>38</sup> [http://www.iso-ne.com/markets/mktmonmit/rpts/other/amr08\\_final\\_061709.pdf](http://www.iso-ne.com/markets/mktmonmit/rpts/other/amr08_final_061709.pdf), page 31

ISOs, black start services are procured through competitive market processes while other ISOs strategically procure black start services through bilateral agreements.

Values for black start come from Isemonger (2006), a paper commissioned by CAISO. Competitors to energy storage for providing black start service are made up of the current service providers, which are generators such as hydroelectric resources and thermal generators with additional onsite distributed generation. In practice, only large underground CAES systems and pumped hydro units will be able to provide this option. In the future, perhaps non-CAES bulk storage options could be considered.

**Table A-16**  
**Black Start**

\$/kW-Yr	Target	High
Black Start	\$4.58	\$8.90

### **Energy Arbitrage**

Energy prices are highly volatile, but tend to show a daily pattern of low prices during nighttime off-peak hours and high prices during daytime on-peak hours. Energy storage can take advantage of this typical daily pattern by storing energy when the price is low and selling energy when the price is high. Price patterns vary by location according to the available generating resources and load patterns. Typical average on-peak to off-peak energy price differentials will be in the \$5–\$30/MWh range. In each region, there are specific locations that exhibit higher price volatility. The average annual energy price differential between the four lowest priced peak-off peak hours and the four highest priced peak-on peak hours are shown in Table A-17. Each region has specific locations that exhibit higher price volatility.

**Table A-17**  
**Annual Average Energy Arbitrage Values**

\$/MWh	CAISO		ERCOT		ISONE		NYISO		PJM	
	Target	High	Target	High	Target	High	Target	High	Target	High
Energy Arbitrage	\$68	\$72	\$38	\$54	\$49	\$51	\$59	\$78	\$87	\$123

### **Non-quantifiable Benefits**

Some benefits identified for energy storage were not modeled for this report. A brief summary of those benefits and the reasons for their exclusion are provided below.

## **Renewable Energy Integration Components**

Due to the number of other benefits included for this report, renewable energy integration was modeled as a single value. This is often the case for high-level policy or planning studies. However, renewable energy integration is actually made up of several components. Two of the benefit values shown presented in this report, VAR support and regulation, are components of renewable energy integration. However, not modeled in this report are the renewable energy integration costs associated with load following/ramp, unit commitment, and the capacity credit accrued by renewable generation<sup>39</sup>. Modeling these benefits requires modeling wind generation output in combination with the regional transmission grid and generating resource portfolio, which is beyond the scope of this study.

## **Renewable Energy Seasonal Output Shifting**

Some energy storage devices such as pumped hydroelectric resources can store energy over long periods of time. Different parts of the electric grid have different seasonal peaking profiles. In warm climates, the peak season is during the summer when the air conditioning load is the highest. In cold climates, the peak season is often in the winter when electrical heating load is high. Large-scale energy storage could be used to shift the excess renewable energy produced in non-peak seasons to be available during peak times. This study focused on shorter-term (intra-day) energy arbitrage and other benefits, which provide higher revenues over the course of a year.

## **Reduce Imbalance Energy Charges**

Imbalance energy charges are assessed by the ISO when load or generation deviates from its designated level beyond a set range (e.g.,  $\pm 10\%$ ). Such deviations are measured in five-minute increments over the course of an hour. Energy storage has the potential to reduce the imbalance energy charges incurred by a utility or generator. Again, modeling this benefit would require incorporating load or output profiles of individual utilities or generators, which is beyond the scope of this study.

## **Reducing Size of Transmission Line**

Reducing the size of a transmission line is one of the benefits that has been identified for energy storage. Transmission lines are long-lived capital assets that are constructed in fixed size increments. This study assumes that transmission line sizes will be determined by a number of factors and that an investment in energy storage would not be considered sufficiently reliable or long-lived to affectively reduce the size of a transmission line. Instead, the benefit of increasing the quantity of wind generation that can be fit through an existing line is modeled.

---

<sup>39</sup> DeCesaro, J., *Wind Energy and Power System Operations: A Review of Wind Integration Studies to Date*, NREL, Golden, Colorado: 2009

## Energy Storage Benefits

Table A-18 presents a summary range of each of the above benefits which can be used as proxies for first-cut Total Resources Cost (TRC) analysis of specific application sites. Each benefit can be broadly categorized as providing operational, reliability, capacity and energy services, as listed down the left side of the table. Each benefit supports one or more sectors of the electric system, from the end user to the regional grid, as displayed across the top. Broadly speaking, the ratio of energy storage (in kW-h) to discharge capacity (in kW) required increases as one moves down the table from operational benefits at the top to energy benefits at the bottom.

Table A-19 converts the energy storage benefit inputs presented above into the present value benefit values that a storage device would be able to accrue over its lifetime. Each benefit is modeled in isolation using a consistent battery configuration of 1 MW of discharge capacity and 2 MWh of energy storage capacity, with a 15-year life and a 10% discount rate. The benefit values in table A-18 include various units based on industry conventions. Table A-19 is designed to compare the benefit values by showing the present value of the benefits over the lifetime of the battery.

## Fossil Plant Operational Cost Savings

Some energy storage pilot projects have been located at fossil generation facilities specifically to reduce the variable operating and maintenance costs.<sup>40</sup> The energy storage technology can provide a rapid response to a regulation or dispatch signal, allowing the fossil unit to respond more slowly. This improves the operating efficiency of the plant, reduces the variable operating costs, and reduces wear and tear on the equipment. However, such a detail operation benefit study was beyond the scope of this report. For more information, see the references provided in the footnote.

---

<sup>40</sup> *Cost Comparison for a 20 MW Flywheel-based Frequency Regulation Power Plant*, KEMA, Inc. Consulting, Raleigh, NC: 2007; *Two Megawatt Advanced Lithium-ion BESS Successfully Demonstrates Potential for Utility Applications*, KEMA, Inc. Consulting: 2008

**Table A-18**  
**Summary Range of Energy Storage Benefits**

	<b>Benefit</b>	<b>Target</b>	<b>High</b>	<b>Units</b>
<b>End User</b>	Power Quality Res.	\$0.10	\$0.60	\$/kW
	Power Quality Com.	\$0.42	\$2.52	\$/kW
	Power Quality Industrial	\$1.40	\$23.80	\$/kW
	Power Reliability Res.	\$5.30	\$31.80	\$/kW
	Power Reliability Com.	\$117.76	\$706.57	\$/kW
	Power Reliability Ind.	\$36.94	\$221.62	\$/kW
	Retail TOU Energy Charges Res.	\$0.17	\$0.27	\$/kWh Price Differential
	Retail TOU Energy Charges Com.	\$0.11	\$0.14	\$/kWh Price Differential
	Retail TOU Energy Charges Ind.	\$0.01	\$0.03	\$/kWh Price Differential
	Retail Demand Charges Res.	\$0.00	\$0.00	\$/kW-Month
	Retail Demand Charges Com.	\$15.00	\$23.00	\$/kW-Month
	Retail Demand Charges Ind.	\$12.00	\$20.00	\$/kW-Month
<b>Dist</b>	Voltage Support	\$3.00	\$8.00	\$/kVAR
	Defer Dist. Investment	\$65.00	\$100.00	\$/kW-yr
	Distribution Losses	0.40%	0.60%	% Net Load Reduction
<b>Trans</b>	VAR Support	\$1.05	\$3.92	\$/kVAR-yr
	Transmission Congestion <sup>1</sup>	\$3.75	\$185.47	\$/kW-yr
	Transmission Access Charges	\$22.05	\$37.58	\$/kW-yr
	Defer Trans. Investment	\$178.00	\$303.00	\$/kW-yr
<b>System</b>	Local Capacity <sup>2</sup>	\$25.74	\$244.16	\$/kW-yr
	System Capacity <sup>2</sup>	\$22.00	\$109.00	\$/kW-yr
	Renewable Energy Integration	\$3.13	\$9.36	\$/MWh
<b>ISO Markets</b>	Fast Regulation <sup>3</sup>	\$13.60	\$92.00	\$/MWh
	Regulation <sup>4</sup>	\$11.60	\$41.07	\$/MWh
	Spinning Reserves <sup>4</sup>	\$4.60	\$26.22	\$/MWh
	Non-Spinning Reserves	\$0.13	\$8.55	\$/MW
	Replacement Reserves	\$0.01	\$1.06	\$/MW
	Black Start	\$4.58	\$8.90	\$/kW-yr
	Price Arbitrage <sup>4</sup>	\$37.58	\$80.50	\$/MWh
1. Range from survey of ISO FTR Auctions 2. Range of Prices from ISO Capacity Auctions 2006-2008 3. Multiplier applied to Regulation Prices 4. Range of annual average ISO market prices 2006-2008				

**Table A-19**  
**Representative Benefit PVs of Selected Energy Storage Benefits**  
**(expressed as \$/kW-h and \$/kW)**

Value Chain	Benefit	PV \$/kW-h		PV \$/kW	
		Target	High	Target	High
End User	1 Power Quality	19	96	571	2,854
	2 Power Reliability	47	234	537	2,686
	3 Retail TOU Energy Charges	377	1,887	543	2,714
	4 Retail Demand Charges	142	708	459	2,297
Distribution	5 Voltage Support	9	45	24	119
	6 Defer Distribution Investment	157	783	298	1,491
	7 Distribution Losses	3	15	5	23
Transmission	8 VAR Support	4	22	17	83
	9 Transmission Congestion	38	191	368	1,838
	10 Transmission Access Charges	134	670	229	1,145
	11 Defer Transmission Investment	414	2,068	1,074	5,372
System	12 Local Capacity	350	1,750	670	3,350
	13 System Capacity	44	220	121	605
	14 Renewable Energy Integration	104	520	311	1,555
ISO Markets	15 Fast Regulation (1 hr)	1,152	1,705	1,152	1,705
	16 Regulation (1 hr)	514	761	514	761
	17 Regulation (15 min)	4,084	6,845	1,021	1,711
	18 Spinning Reserves	80	400	110	550
	19 Non-Spinning Reserves	6	30	16	80
	20 Black Start	28	140	54	270
	21 Price Arbitrage	67	335	100	500

Note: each benefit is modeled in isolation using a consistent battery configuration of 1 MW of discharge capacity and 2 MWh of energy storage capacity, with a 15-year life and a 10% discount rate.

## Energy Storage Applications

A variety of data sources and prior studies were used to develop estimated benefit values. For each benefit, two estimates were provided: an average value designed to be representative of the broader market, and a high value estimate for premium or niche markets. For those benefits bid into competitive markets, historical price data from 2006-2008 for five ISOs—CAISO, ERCOT, ISONE, NYISO and PJM—was used. For each ISO, one year was selected to represent the

average value and one year the high value for each benefit modeled. Concurrent historical data was used to the extent available to reflect the relative values of different benefits that actually occurred in the energy markets over the period studied. A recognized limitation of this approach is that the 2006-2008 period covered is not necessarily representative of potential revenues over the operating life of the technology modeled.

### Modeling Approach

The operation of each energy storage /application combination is simulated over the course of one year in an Excel/Visual Basic model. The technical specifications of the technology constrain the operations of the modeled storage device, accounting for charging and discharging capacity (in MW), energy storage capacity (in kW-h), and round-trip efficiency, among other factors. Within those constraints, the device is dispatched based on expected prices to maximize revenue over the course of a day. For each application selected ratios of discharge capacity to energy storage capacity were modeled.

End-user reliability applications require maintaining the battery at or near full capacity throughout the year, as customer outages can occur at any time. For specific applications, revenue was maximized with a two-mode operation (Figure A-7). During a selected number of peak hours the device is kept full to provide local or system capacity and local voltage support (Mode 1). Maintaining full capacity, however, prevents the battery from participating in ancillary service and energy markets. For the remaining hours, the battery is free to cycle up and down to provide a greater range of benefits, including time shifting, energy arbitrage and ancillary services (Mode 2).

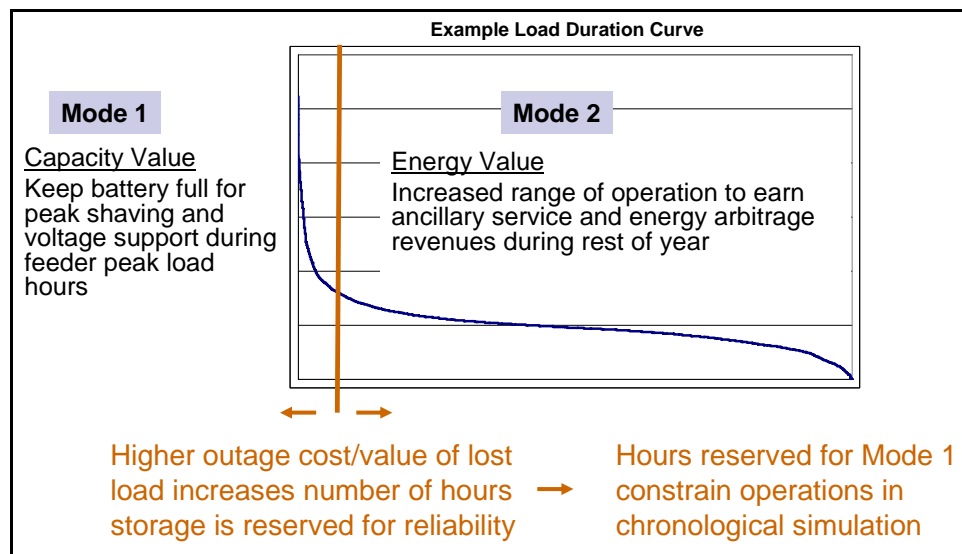

**Figure A-7**  
**Two-Mode Operation**

For wholesale market applications, the model could choose between energy, regulation and spinning reserve markets to maximize revenue over the course of a day based on expected prices.

(Due to their relatively low prices, non-spin/replacement reserves prices were not modeled on an hourly basis.) To forecast energy and ancillary service market prices, a simple strategy of averaging prices over the previous two weeks was employed. A number of simple methods for predicting prices based on day-ahead or previous-day real-time prices were evaluated but did not improve upon these results.

Even with perfect foresight, however, a strategy of actively switching between two markets did not improve revenues in most cases. Devices that can provide regulation earned an insignificant amount of incremental revenue engaging in energy arbitrage. Such devices were therefore modeled as providing regulation only. When regulation was excluded as a potential benefit, switching between spinning reserves and energy arbitrage maximized revenues only in select cases.

### **Present Value**

For each application, the total annual revenues produced by the model were extrapolated over the expected useful life of the storage device. A simple present value (PV) of those revenues was calculated using a 10% discount rate. That PV was then divided by the discharge capacity and energy storage capacity to calculate a \$/kW and \$/kW-h value for each application.

The PV for a storage application is a good first-cut estimate for how much a utility could justify investing in a storage system. Each utility will have different business case metrics. Other considerations such as life-cycle costs, service and maintenance, and site-specific application variables will also be key factors in making the business case and selecting a specific technology.

The annual benefit is calculated for each application extended over the expected useful life of the storage system. A simple PV of those revenues is calculated using a discount rate (10% was used in these examples) to approximate the perspective of a regulated utility considering an investment in energy storage. The PV of the revenues was then divided by the energy storage capacity (in kW-h) to calculate a \$/kW-h present value for each application.

The PV analysis sums all the benefits provided by the energy storage system, irrespective of which stakeholder stands to receive the benefit. This approach is analogous to the Total Resources Cost (TRC) test, which evaluates the costs and benefits to the region as a whole, regardless of who pays the costs or who receives the benefits. The regional or TRC perspective is often used by utilities and regulators to evaluate the cost-effectiveness of investments in energy efficiency or other programs. These have been estimated using input data from all the ISOs below.

### **Gap Analysis**

For the gap chart analysis, all technologies are compared over a 15-year lifetime—which is not to say that the expected lifetime of each storage technology is 15 years. Assumptions are made for each technology and then leveled for a 15 year project lifetime. The assumptions regarding storage technology lifetimes and application present values for the gap charts are shown in Table



A-20. Figures A-8 through A-24 show the individual gap charts for each application with technologies broken out in order to give a more detailed look at the gap analysis.

**Table A-20**  
**Gap Chart Assumptions**

Comparison Assumptions		
Expected lifetime for comparison (lifetime of project)		15
Discount Rate for Comparison		10%
Application Present Values (\$/kWh) assumed for 15 year, 10% discount		
Application	Target Value	High Value
2 hr Res Backup	\$9	\$117
15 Min Res Backup	\$19	\$320
Res Energy Mgmt	\$205	\$390
ESCO	\$399	\$624
ESCO w Reg Local Cap	\$977	\$1,387
DESS Com Cust	\$349	\$662
DESS Com Cust w Local Cap	\$464	\$939
Com 15 min Reliability	\$80	\$1,295
Com 4 hour Reliability	\$113	\$1,325
Com Energy Management	\$237	\$337
Com Energy Mgmt w Dist Benefits	\$515	\$761
Sta T&D Support	\$295	\$489
Sta T&D w Reg LCAP Def	\$1,390	\$2,462
Trans T&D Support	\$470	\$810
Trans T&D w Reg LCap Def	\$2,171	\$3,819
Wholesale Freq Reg (15 Min)	\$4,084	\$6,845
Wholesale Arbitrage	\$355	\$411
Wholesale Arb w Reg LCap Tx	\$823	\$1,375
Remote Wind	\$92	\$351
Storage Lifetime By Technology	Low	High
Pumped Hydro	30	40
CAES Underground	15	20
CAES Above Ground	20	20
FlyWheel	20	20
ZnBr	15	20
ZnAir	15	20
Vanadium Redox	15	20
NaS	15	20
Li-ion	15	20
FeCr	15	20
Advanced Lead Acid	15	20

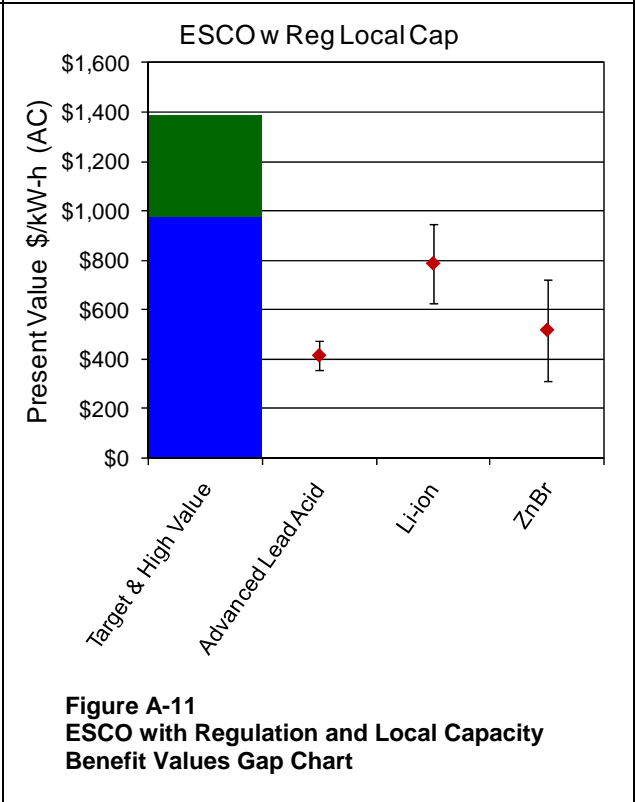
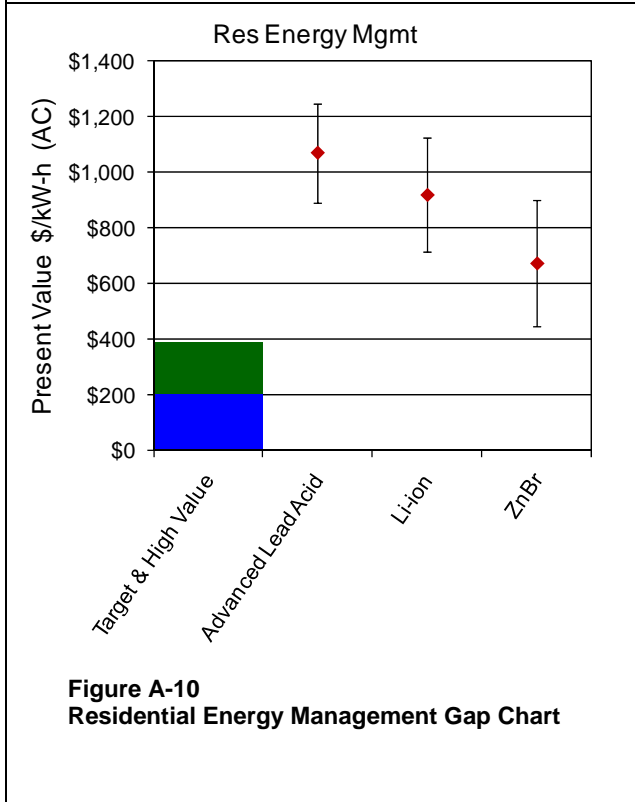
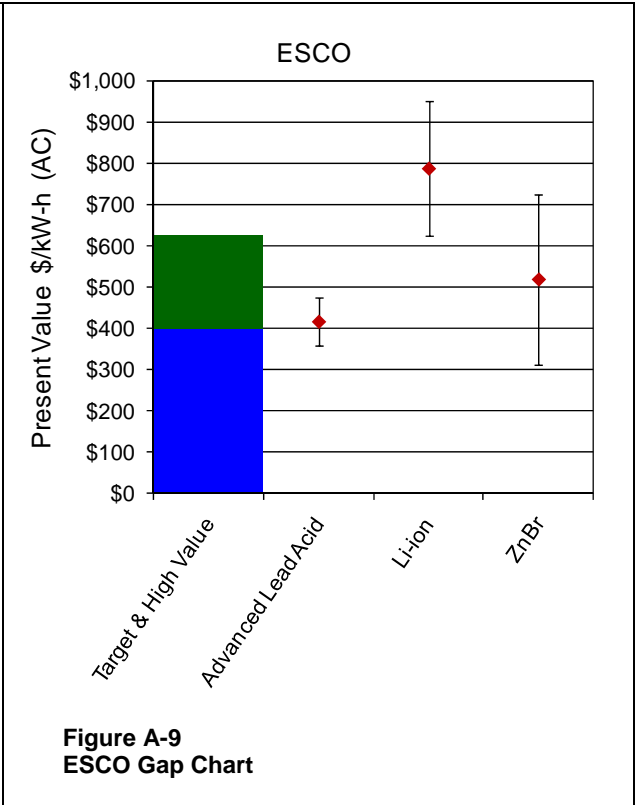
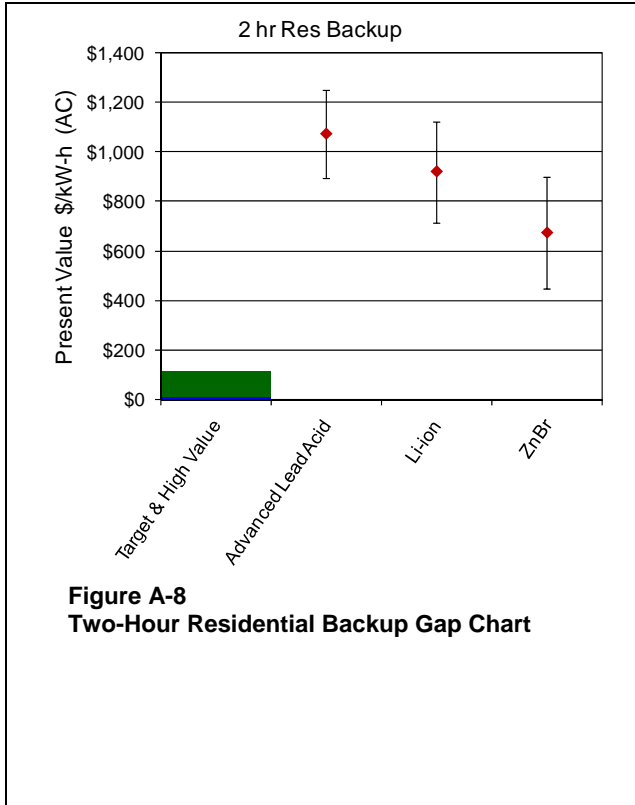

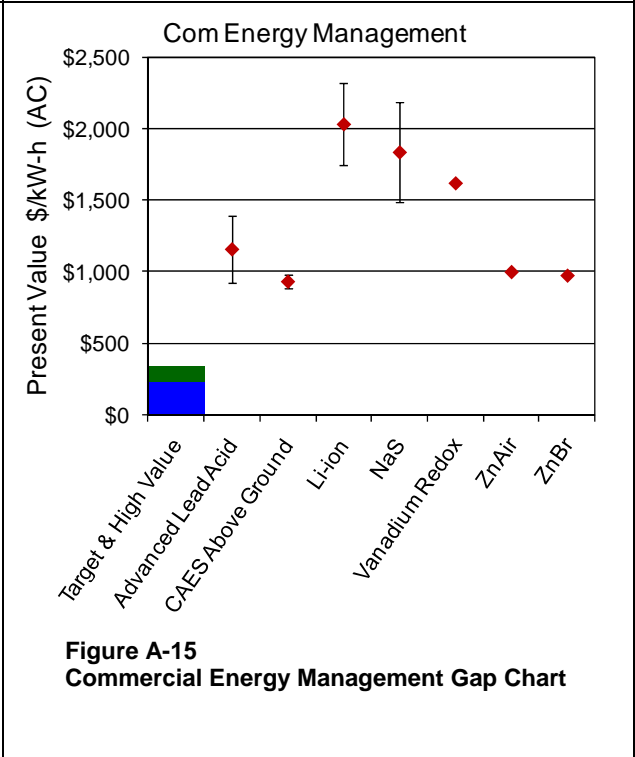
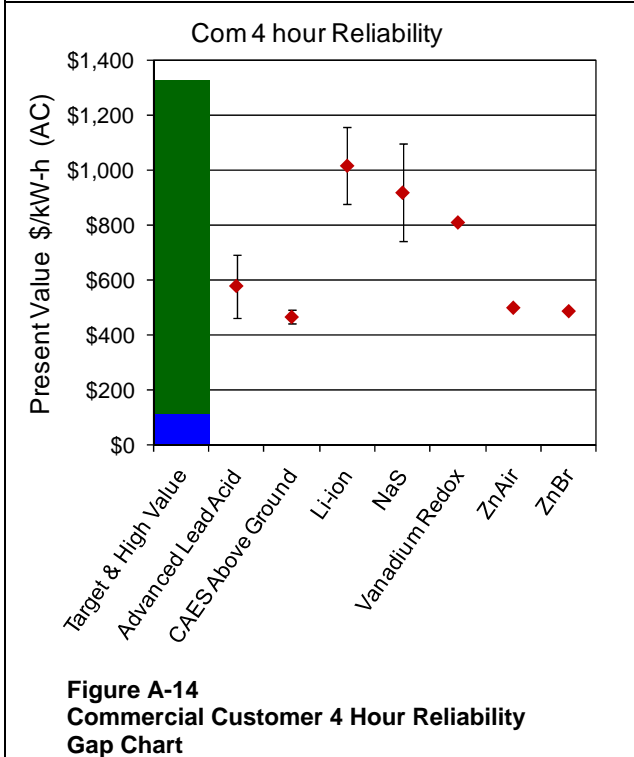
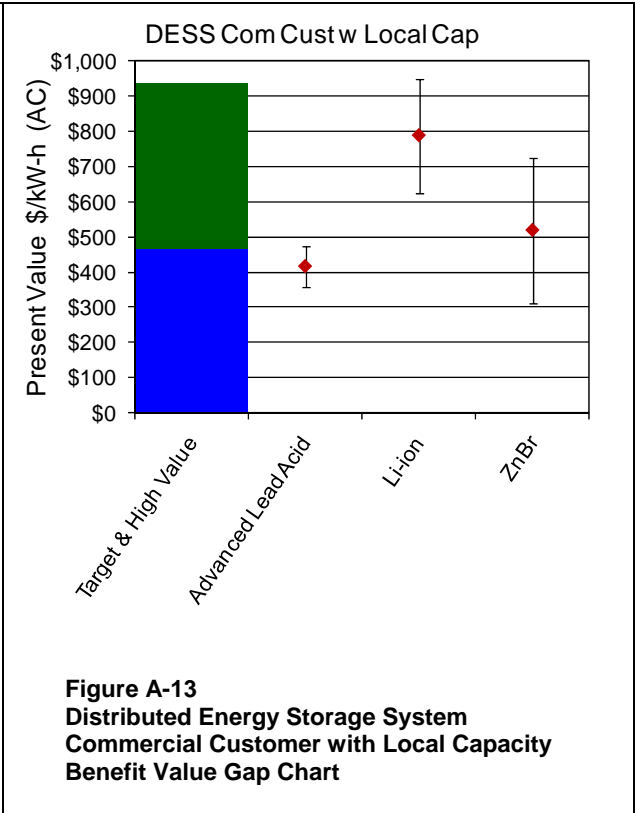
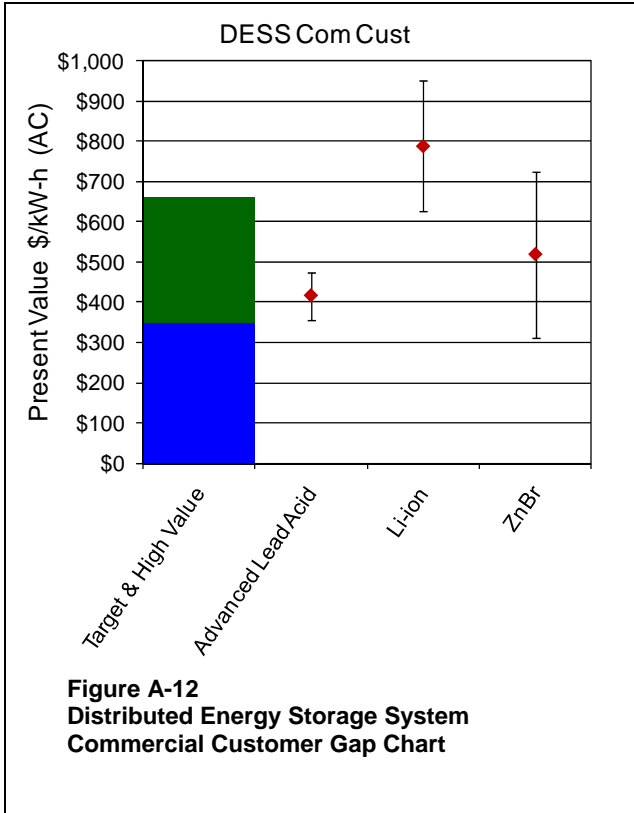

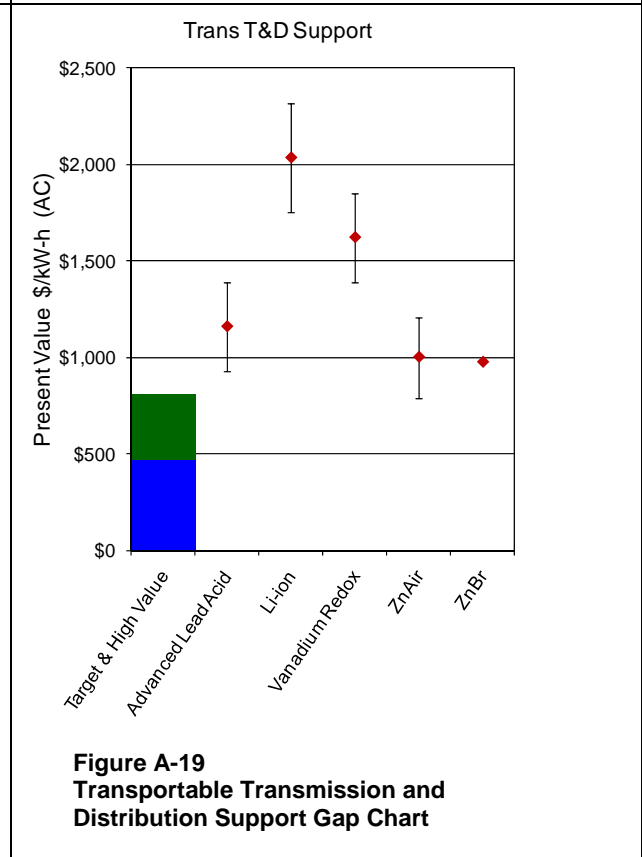
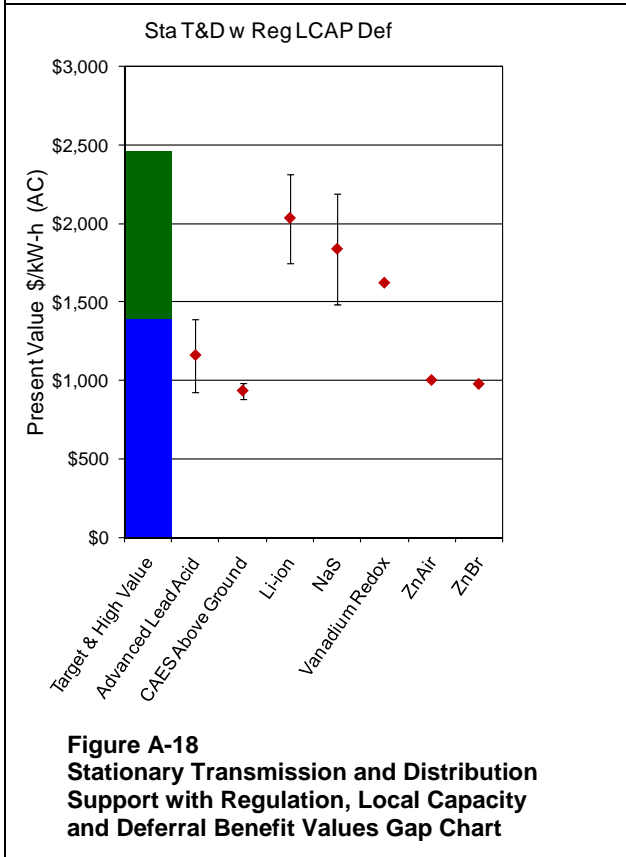
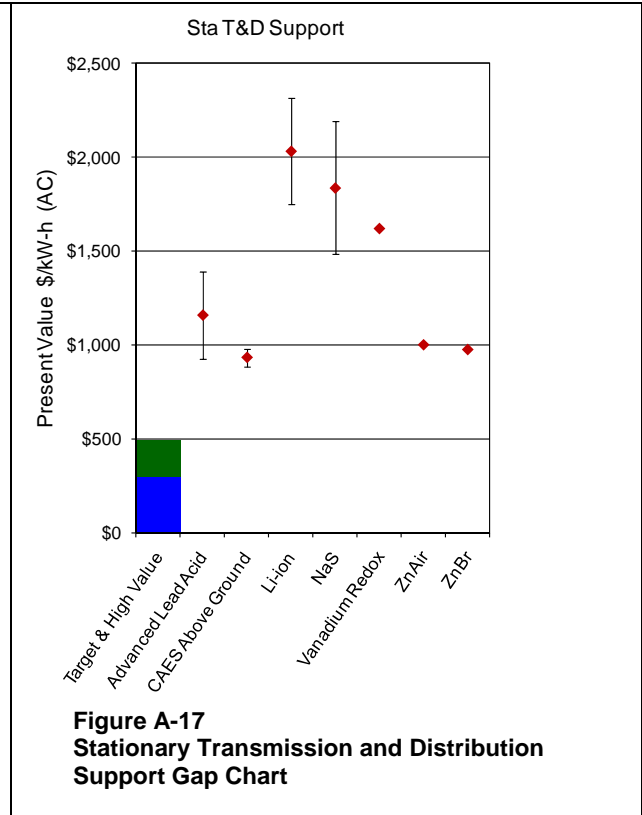
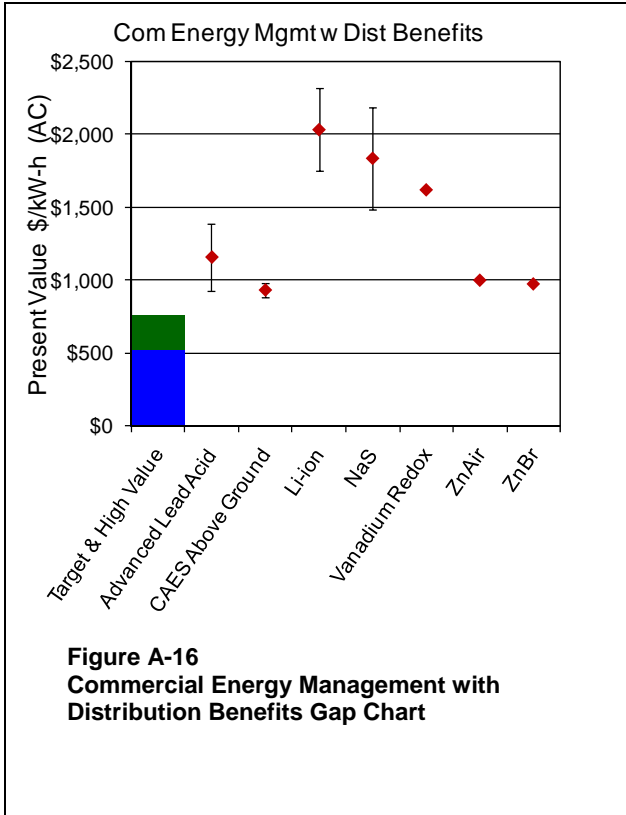

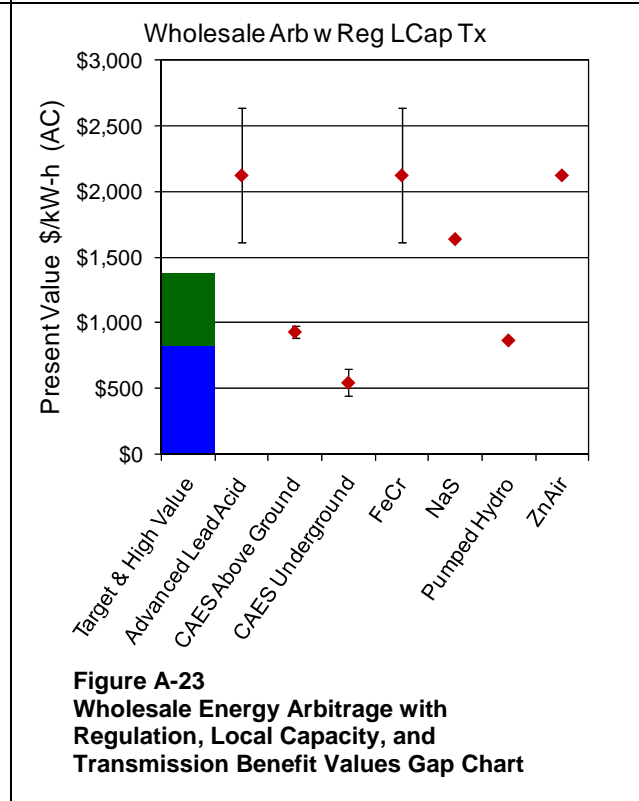
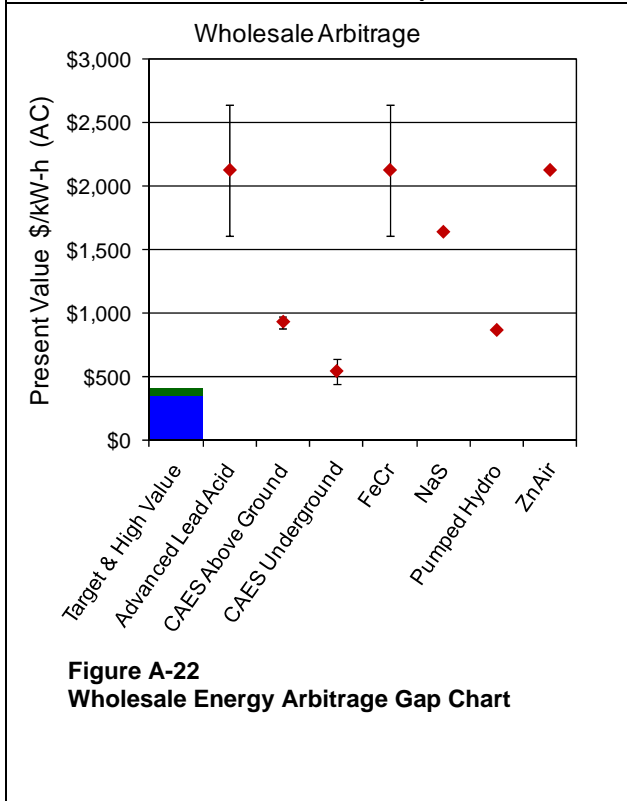
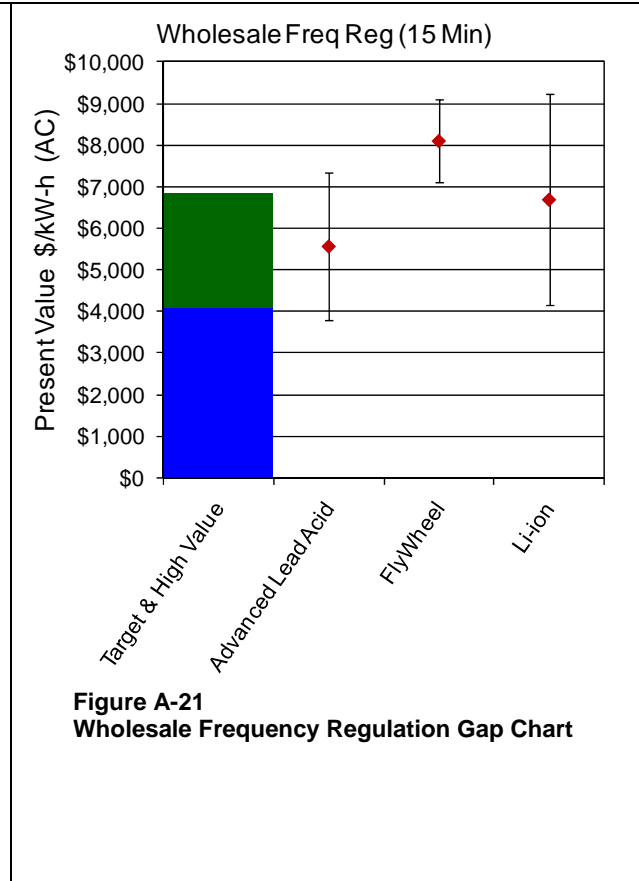
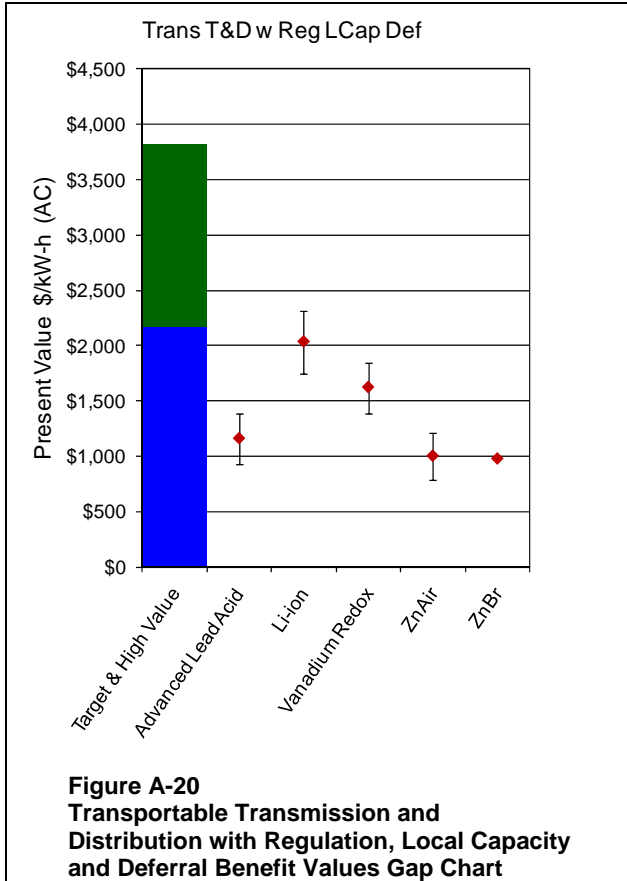

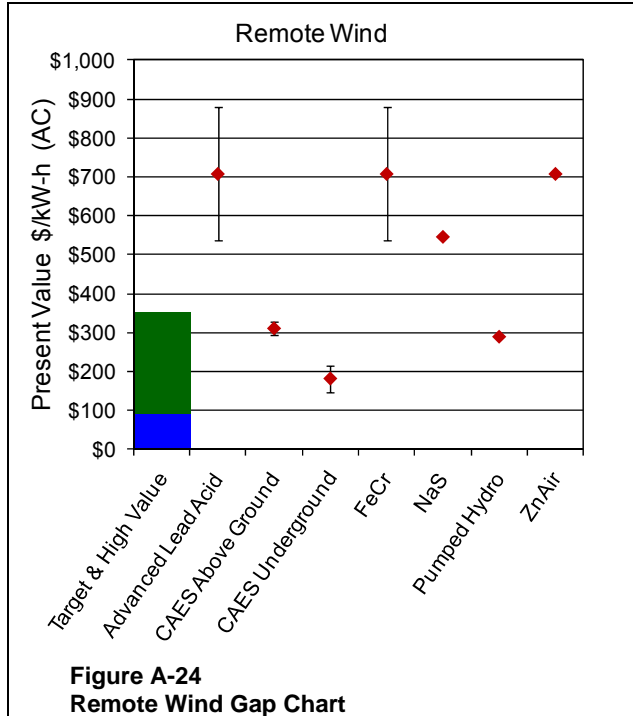

## Levelized Cost Assumptions

The levelized cost of generation is a useful metric for comparing costs across a wide range of resources and technologies. It is frequently used in regulatory review and long-term resource planning to compare the costs of different investment strategies and resource portfolios under a wide range of potential future scenarios. Levelized costs can be calculated using a limited number of inputs, which makes them useful for evaluating costs of technologies with limited operational experience or data.

As a simplified approach for comparing costs across technologies, a levelized cost analysis focuses on a limited number of inputs that are the key drivers of cost. A levelized cost analysis typically does not attempt to capture detailed financial or operational assumptions and should be understood in this context. The financial pro-forma or cost-benefit analysis for purchasing or investment decisions are usually far more detailed. As an example, a levelized cost analysis will often rely on an assumed capacity factor for each type of generating technology, but will not perform an hourly dispatch against market prices or system loads.

A levelized cost analysis begins with establishing the financial ownership structure for the resource. At a minimum this differentiates ownership by a municipal utility, investor owned utility and unregulated, independent company. The debt to equity ratio, the cost of debt and cost of equity appropriate to each ownership structure is used to calculate a single Weighted Average Cost of Capital (WACC). The after-tax WACC, which accounts for the tax deduction for interest paid debt, is typically used in financial analysis. A typical WACC for a municipal utility

is 4-6%, representing the interest cost for municipal debt (with no taxes or tax deduction). A regulated utility will usually have an after-tax WACC of 7-8%, while an independent power producer would have a WACC of 10% or more. As shown in A-21, the after-tax WACC used for this analysis is 10.46%. The WACC established the discount rate used to calculate present values of costs and benefits over the life of the asset, and the resulting levelized cost.

The capital costs of the resource are usually expressed as a \$/kW installed. This figure includes all the costs to purchase and install the plant. The \$/kW capital cost multiplied by the size of the plant produces the total cost of the project. For this analysis all costs are expressed in total \$/kW of usable discharge capacity (in kW) and total \$/kWh of usable energy storage capacity (e.g. the two costs figures are duplicative, not additive). All else equal, systems with a higher usable state of charge will have a lower unit cost in dollars per usable kW and kWh.

The WACC is then used to calculate the annual payment required to recover the capital cost of the plant as well as the cost of debt (interest) and cost of equity (return on equity or ROE) to finance the project. An alternative approach uses the same inputs to calculate a Real Economic Carrying Charge (RECC), which is multiplied by the capital cost to calculate a levelized annual payment. To illustrate, A WACC of 9.0 percent for an asset with a 20 year life yields a RECC of 11 percent. This means that 11 percent of the capital cost must be paid every year for 20 years to provide a rate of return of 9.0 percent.

Fixed O&M, expressed in \$/kW-Yr. is also added to the annual cost. Because O&M costs were difficult to obtain or unknown for most technologies, an assumption of roughly 0.5% and 2.0% of the capital costs (in \$/kW) were used to represent the low and high annual fixed O&M costs in \$/kW-Yr. Additional fixed costs for insurance and property tax are included on an annual basis as a percentage of the capital costs.

The annual generation produced by the plant is calculated using an assumed capacity factor. This analysis relied on two simple assumptions for the capacity factor; a capacity factor of 18 percent for the Regulation application, and a capacity factor calculated based on 1 cycle per day for all other applications (except Lead Acid with 2,200 cycles, which was limited to 110 cycles per year). This assumption of 1 cycle per day means that technologies with a higher usable state of charge will have a correspondingly higher capacity factor. The AC/AC efficiency does not affect the capacity factor, but a higher efficiency does result in a lower charging cost for the same level of output. The charging cost is also dependent on the off-peak power electric cost. A battery with a 80% ac-ac efficiency and an off-peak power costs of \$ 30 MWh will have an operating costs of  $\$30 \text{ MWh} / (0.80)$  or  $\$38/\text{MWh}$ . For CAES technology, fuel costs must also be included and are calculated based on an assumed heat rate in LHV, and the energy ratio, which is the kWh input required for each kWh of output (e.g. the inverse of the AC/AC efficiency, which is the kWh output/kWh input). The CAES operating costs are  $\text{Heat rate (LHV)} / 1.1 * \text{fuel costs} + \text{Energy ratio} (0.7) * \text{cost of off peak power} + \text{O\&M costs}$ . Fuel costs of \$6.50/MMBtu and \$8.00/MMBtu are used for the low and high case respectively.

The levelized costs are calculated by dividing the annual costs by the annual generation. For this analysis no degradation of delivery or energy storage capacity was included. Instead, it was

assumed that the fixed O&M costs included the maintenance necessary to maintain a constant level of capacity over the life of the technology.

The following tables summarize the assumptions applied to the analysis of levelized cost. Table A-21 provides assumptions applied in all cases, while Tables A-22 through A-25 detail assumptions used when calculating levelized cost for various energy storage options used for Frequency Regulation and T&D Grid Support applications. The key differences between the low and high cases are the capital costs, useful life, efficiency, O&M costs, and delivered kilowatt-hours over the useful life. The cycle life of Li-ion batteries and flywheels is particularly uncertain in the frequency regulation application, which requires many cycles over the project life. With limited operational experience, the O&M cost estimates are particularly uncertain. Refining these data and reducing their uncertainties will be the focus of future research.



**Table A-21**  
**Wholesale Energy Arbitrage Gap Chart**

Common Assumptions	
Ownership	IPP
Debt	40%
Equity	60%
Debt Rate	7.49%
Equity Return	14.47%
Pre-Tax WACC	11.68%
After Tax WACC	10.46%
Federal Tax	35%
State Tax	9%
Total Tax	41%
Inflation	2.50%
Fuel Inflation (Real)	3.00%
Insurance	0.50%
Property Tax	1.00%
Charging Cost (\$/kWh)	\$0.05
Fuel Cost Low (\$/MMBtu)	\$6.50
Fuel Cost High (\$/MMBtu)	\$8.00
CO2 Emissions (Lb/MMBtu)	117
CO2 Price (\$/Ton)	\$30.00

**Table A-22**  
**Levelized Cost Assumptions: Frequency Regulation**

Frequency Regulation							
Assumptions		Li-ion		Adv. Lead Acid		Flywheel	
		Low	High	Low	High	Low	High
Size	kW	1,000	1,000	1,000	1,000	20,000	20,000
	kW-h	250	250	250	250	5,000	5,000
Life	Cycles	6300	16300	6,300	6,300	150,000	150,000
	Years	20	15	20	15	20	15
Usable SOC AC/AC Efficiency		80%	80%	80%	80%	90%	80%
		90%	85%	90%	75%	90%	85%
Cost	\$/kW	\$1,085	\$1,550	\$950	\$1150	\$1,950	\$2,220
	\$/kW-h	\$4,340	\$6,200	\$3,800	\$4,600	\$7,800	\$8,800
O&M	\$/kW-Yr.	\$10	\$100	\$15	\$90	\$5	\$10
Capacity Factor		18%	18%	18%	18%	18%	18%

**Table A-23**  
**Levelized Cost Assumptions: T&D Grid Support (CAES, Lead-Acid, NaS)**

T&D Grid Support									
Assumptions		CAES (AG)		Lead Acid 4,500		Lead Acid 2,200		NaS	
		Low	High	Low	High	Low	High	Low	High
Size	kW	50,000	50,000	1,000	1,000	1,000	1,000	1,000	1,000
	kW-h	250,000	250,000	4,000	4,000	4,000	4,000	7,200	7,200
Life	Cycles	15,000	15,000	4,500	4,500	2,200	2,200	4,250	4,250
	Years	20	20	20	15	20	15	20	15
Usable SOC		--	--	33%	33%	70%	70%	80%	80%
	AC/AC Efficiency	--	--	90%	85%	90%	85%	83%	78%
Cost	\$/kW	\$1,950	\$2,150	\$2,000	\$2,400	\$1,700	\$1,900	\$3,200	\$4,000
	\$/kW-h	\$390	\$430	\$500	\$600	\$425	\$475	\$444	\$556
O&M	\$/kW-Yr.	\$4	\$6	\$10	\$50	\$25	\$50	\$16	\$50
	\$/MWH	\$4	\$5						
Capacity Factor		26%	26%	14%	14%	5%	5%	25%	25%
Heat Rate		4,090	4090						
Natural Gas		\$7	\$8						

**Table A-24**  
**Levelized Cost Assumptions: T&D Grid Support (Zn/Br, Vanadium Redox, Advanced Lead-Acid, Li-ion)**

T&D Grid Support									
Assumptions		Zn/Br		Vanadium Redox		Adv. Lead Acid		Li-ion	
		Low	High	Low	High	Low	High	Low	High
Size	kW	1,000	1,000	1,000	1,000	1,000	1,000	1,000	1,000
	kW-h	5,000	5,000	4,000	4,000	4,000	4,000	4,000	4,000
Life	Cycles	4,500	4,500	4,500	4,500	4,500	4,500	10,000	10,000
	Years	20	15	20	15	20	15	20	15
Usable SOC		80%	80%	80%	80%	80%	80%	80%	80%
AC/AC Efficiency		68%	63%	67%	62%	90%	60%	90%	85%
Cost	\$/kW	\$1,725	\$2000	\$3,000	\$3,320	\$2,00	\$4,600	\$3,850	\$4,100
	\$/kW-h	\$345	\$400	\$750	\$830	\$500	\$1150	\$963	\$1,025
O&M	\$/kW-Yr.	\$8	\$40	\$15	\$50	\$25	\$50	\$9	\$70
Capacity Factor		21%	21%	18%	18%	18%	18%	18%	18%

**Table A-25**  
**Levelized Cost Assumptions: T&D Grid Support (Zn/Br, Vanadium Redox, Advanced Lead-Acid, Li-ion)**

Renewable Integration/Time Shifting									
Assumptions		Pumped Hydro		CAES–Belowground		Sodium-Sulfur		Vanadium Redox	
		Low	High	Low	High	Low	High	Low	High
Size	MW	280	1400	400	400	50	50	50	50
	MW-h	1680	14,000	3,200	3,200	300	300	250	250
Life	Cycles	>10000	>10000	4,500	4,500	4,500	4,500	10,000	10,000
	Years	50	50	20	10	20	15	20	15
Usable SOC		80%	80%	--	---	80%	80%	80%	80%
AC/AC Efficiency		82%	80%	---	---	80%	75%	70%	65%
Cost	\$/kW	\$1,500	\$2700	\$960	\$1,250	\$3,100	\$3,300	\$3,100	\$3,300
	\$/kW-h	\$250	\$270	\$120	\$146	\$517	\$550	\$620	\$660
O&M	\$/kW-Yr.	\$8	\$413	\$4	\$6	\$16	\$50	\$16	\$50
	\$/MWH			\$4	\$5				
Capacity Factor		24%	24%	18%	18%	18%	18%	18%	18%
Heat Rate	Btu/kWh			3845	3860				

## REFERENCES

---

1. *A Feasibility Analysis of Limited Energy Storage for Regulation Service*, EPRI, Palo Alto, CA: November 2009. 1020399.
2. *Market Requirements and Opportunities for Distributed Energy Storage Systems in the Commercial Sector Leveraging Energy Efficiency Initiatives*, EPRI, Palo Alto, CA: November 2008. 1016015.
3. DeCesaro, J., *Wind Energy and Power System Operations: A Review of Wind Integration Studies to Date*, NREL, Golden, Colorado: 2009
4. *Discussion Paper Renewable Integration: Market and Product Review*. CAISO, July 2009, <http://www.caiso.com/27cd/27cdeb8548450.pdf>
5. *Emissions Comparison for a 20-MW Flywheel-based Frequency Regulation Power Plant*, KEMA, Raleigh, NC: January 2007 (Project: BPCC.0003.001)
6. *Energy Storage Market Opportunities: Application Value Analysis and Technology Gap Assessment*, EPRI, Palo Alto, CA: 2009. 1017813.
7. *Economic and Greenhouse Gas Emission Assessment of Utilizing Energy Storage Systems in ERCOT*, EPRI, Palo Alto, CA: September 2009. 1017824.
8. Holttinen, H., et al., *Design and Operation of Power Systems with Large Amounts of Wind Power Final Report*. IEA Wind Task 25, Phase One (2009).
9. *CAISO Market Issues & Performance 2009 Annual Report*, Department of Market Monitoring, California Independent System Operator Corp.: April 2010.
10. *Energy Storage for the Electricity Grid: Benefits and Market Potential Assessment Guide*, Sandia National Laboratories, Albuquerque, NM: February 2010.
11. *Assessing the Value of Regulation Resources Based on Their Time Response Characteristics*, Pacific Northwest National Laboratory, Richland, WA: 2008 (PNNL 2008a).
12. Isemonger, A.G., "The Competitive Procurement of Voltage Support" June 2006, California Independent System Operator, White Paper.
13. Open Access Technology International Inc., "Assessment of Historical Transmission Congestion in the Eastern Interconnection," July 2009, Department of Energy, version 1.2

14. Smith, J. C., et al., *Utility Wind Integration and Operating Impact State of the Art*. IEEE Transactions On Power Systems 22.3 (2007): 900-08.
15. *Cost of New Entry Combustion Turbine Power Plant Revenue Requirements, Additional CONE Area Evaluation for PJM Interconnection*, Pasteris Energy, Inc, Yardley, PA: 2009 (Pasteris 2009).
16. *2009 State of the Market Report*, NYISO Electricity Markets Presentation. David Patton, Ph.D, Patomac Economics, April 2010 (Patton 2010).
17. *The Power to Reduce CO<sub>2</sub> Emissions: The Full Portfolio*, EPRI, Palo Alto, CA: 2009. 1019563.
18. *Prism/MERGE Analyses: 2009 Update*, EPRI, Palo Alto, CA: 2009. 1020389
19. *Functional Requirements for Electric Energy Storage Applications on the Power System Grid*, EPRI, Palo Alto, CA: 2010. 1020075.
20. *Energy Storage Technology and Application Cost and Performance Database*, EPRI Palo Alto, CA: 2010. 1020071
21. *Reference Designs of 50-MW / 250-MWh Energy Storage Systems*, EPRI Palo Alto, CA: 2010. 1021117.
22. *Analysis of Energy Storage Systems to Address Regional Wind Penetration: Cases Studies in PJM, NYISO, and ERCOT*, EPRI Palo Alto: 2010. 1020082.
23. *Cost Comparison for a 20 MW Flywheel-based Frequency Regulation Power Plant*, KEMA, Inc. Consulting, Raleigh, NC: 2007
24. *Two Megawatt Advanced Lithium-ion BESS Successfully Demonstrates Potential for Utility Applications*, KEMA, Inc. Consulting: 2008



**The Electric Power Research Institute Inc.,** (EPRI, [www.epri.com](http://www.epri.com)) conducts research and development relating to the generation, delivery and use of electricity for the benefit of the public. An independent, nonprofit organization, EPRI brings together its scientists and engineers as well as experts from academia and industry to help address challenges in electricity, including reliability, efficiency, health, safety and the environment. EPRI also provides technology, policy and economic analyses to drive long-range research and development planning, and supports research in emerging technologies. EPRI's members represent more than 90 percent of the electricity generated and delivered in the United States, and international participation extends to 40 countries. EPRI's principal offices and laboratories are located in Palo Alto, Calif.; Charlotte, N.C.; Knoxville, Tenn.; and Lenox, Mass.

Together...Shaping the Future of Electricity

**Program:**

Energy Storage

© 2010 Electric Power Research Institute (EPRI), Inc. All rights reserved. Electric Power Research Institute, EPRI, and TOGETHER...SHAPING THE FUTURE OF ELECTRICITY are registered service marks of the Electric Power Research Institute, Inc.

1020676